



Japan International Cooperation Agency (JICA)
Oromia Irrigation Development Authority (OIDA)

Manual for Runoff Analysis

May, 2014

The Project for Capacity Building in Irrigation Development (CBID)



Foreword

Oromia Irrigation Development Authority (OIDA) is established on June, 2013, as a responsible body for all irrigation development activities in the Region, according to Oromia National Regional Government proclamation No. 180/2005. The major purposes of the establishment are to accelerate irrigation development in the Region, utilize limited resources efficiently, coordinate all irrigation development activities under one institution with more efficiency and effectiveness.

To improve irrigation development activities in the Region, the previous Oromia Water Mineral and Energy Bureau entered into an agreement with Japan International Cooperation Agency (JICA) for “The Project for Capacity Building in Irrigation Development (CBID)” since June, 2009 until May, 2014. CBID put much effort to capacitate Irrigation experts in Oromia Region through several activities and finally made fruitful results for irrigation development. Accordingly, irrigation projects are constructed and rehabilitated based on that several Guidelines & Manuals and texts produced which can result in a radical change when implemented properly.

Herewith this message, I emphasize that from Now on, OIDA to make efforts to utilize all outputs of the project for all irrigation activities as a minimum standard, especially for the enhancement of irrigation technical capacity.

I believe that all OIDA irrigation experts work very hard with their respective disciplines using CBID outputs to improve the life standard of all people. In addition, I encourage that all other Ethiopian regions to benefit from the outputs.

Finally, I would like to thank the Japanese Government, JICA Ethiopia Office, and all Japanese and Ethiopian experts who made great effort to produce these outputs.

Feyisa Asefa Adugna

General Manager

Oromia Irrigation Development
Authority

Addis Ababa, Ethiopia
May, 2014

Introductory Remarks

“Growth and Transformation Plan” (GTP) from 2011 to 2015 intensifies use of the country’s water and other natural resources to promote multiple cropping, better adaptation to climate variability and ensure food security. Expansion of small scale irrigation schemes is given a priority, while attention is also given to medium and large scale irrigation.

In Oromia Region, it is estimated that there exists more than 1.7 million ha of land suitable for irrigation development. However, only 800,000 ha is under irrigation through Traditional and Modern irrigation technology. To accelerate speed of Irrigation Development, the Oromia National Regional State requested Japan International Cooperation Agency (JICA) for support on capacity building of Irrigation Experts under Irrigation Sector.

In response to the requests, JICA had conducted "Study on Meki Irrigation and Rural Development" (from September 2000 to January 2002) and Project for Irrigation Farming Improvement (IFI project) (from September 2005 to August 2008). After implementation of them there are needs to improve situation on irrigation sector in Oromia Region.

JICA and the Government of Ethiopia agreed to implement a new project, named “The project for Capacity Building in Irrigation Development” (CBID). The period of CBID is five years since June, 2009 to May, 2014 and main purpose is to enhance capacity of Irrigation Experts in Oromia Region focusing on the following three areas, 1) Water resources planning, 2) Study/Design/Construction management, 3) Scheme management through Training, On the Job Training at site level, Workshops, Field Visit and so on and to produce standard guidelines and manuals for Irrigation Development.

These guidelines and manuals (Total: fourteen (14) guidelines and manuals) are one of the most important outputs of CBID. They are produced as standards of Irrigation Development in Oromia Region through collecting different experiences and implementation of activities by CBID together with Oromia Irrigation Experts and Japanese Experts.

These guidelines and manuals are very useful to improve the Capacity of OIDA Experts to work more effectively and efficiently and also can accelerate Irrigation Development specially in Oromia Region and generally in the country.

Finally, I strongly demand all Irrigation Experts in the region to follow the guidelines and manuals for all steps of Irrigation Development for sustainable development of irrigation.

Adugna Jabessa Shuba

D/General Manager & Head, Study,
Design, Contract Administration &
Construction Supervision

Oromia Irrigation Development
Authority

Addis Ababa, Ethiopia
May, 2014

TABLE OF CONTENTS

1. INTRODUCTION	1
1.1 Purpose of Runoff Calculation	1
1.2 Contents of Runoff Calculation.....	1
2. DATA.....	2
2.1 Available Data.....	2
2.1.1 Meteorological Data.....	2
2.1.2 Hydrological Data.....	2
2.1.3 Data of Basin Condition	2
2.2 Data Handling	2
2.2.1 Hydrological Year	3
2.2.2 Leap Year	3
2.2.3 Boundary of the Day	3
2.3 Complementation of the Missing Data	3
2.3.1 Missing Data and Abnormal Data	3
2.3.2 Ratio of Catchment Area	5
2.3.3 Correlation.....	5
3. RUNOFF MODEL.....	6
3.1 Response Model.....	6
3.2 Physical Model.....	6
3.3 Selection of Suitable Model	7
4. OBJECTIVES.....	8
4.1 Planning Basins.....	8
4.2 Period for Planning	8
5. TANK MODEL.....	9
5.1 Outline of Tank Model.....	12
5.2 Parameters	12
6. DATA OF TANK MODEL	13
6.1 Input Data	13
6.1.1 Rainfall	13
6.1.2 Evapotranspiration and Loss	13
6.1.3 Initial Storage	14

6.2 Discharge Data	14
7. EXAMPLE OF CALCULATION BY TANK MODEL	15
7.1 Calculation Procedure	15
7.2 Parameters	15
7.3 Initial Conditions	16
7.4 Input Data	16
7.5 Calculation	16
8. IDENTIFICATION PROCEDURE AND VERIFICATION OF TANK MODEL	18
8.1 Data Period for Evaluation	18
8.2 Identification Procedure	19
8.2.1 Characteristics of Parameter in General	19
8.2.2 Characteristics of Parameter on Inter-Tank	19
8.2.3 Adjustment of Parameter for Each Component	20
8.3 Verification	21
ANNEX-01 CONCEPT OF RUNOFF FROM TANK	23
ANNEX-02 HYDROLOGICAL YEAR AND LEAP YEAR	24
ANNEX-03 EVAPORATION DATA	25
ANNEX-04 LOSS	26
ANNEX-05 ArcSWAT	27
ANNEX-06 THIESSEN POLYGON	28
ANNEX-07 EXAMPLE OF THIESSEN COEFFICIENT	29
ANNEX-08 MEASUREMENT OF AREA	30
ANNEX-09 ARF (AREAL REDUCTION FACTOR)	32
ANNEX-10 CONDITION OF DATA OBSERVATION	33
ANNEX-11 H-Q RELATIONSHIP	34
ANNEX-12 DIAGRAM MAKING OF HYDROGRAPH	36
ANNEX-13 BOUNBARY OF THE DAY	39
ANNEX-14 CORRELATION CALCULATION	40
ANNEX-15 CORRELATION OF DISCHARGE	43
ANNEX-16 GRAPH OF NORMAL AND LOG SCALE	44
ANNEX-17 CALCULATION FORMAT OF TANK MODEL	45
References	52
List of Authors/Experts/Editors/Coordinators	53

1. INTRODUCTION

Continuous long-term hydrological data is absolutely necessary to water resources planning. Rainfall data and discharge data are essential for the water resources planning. Rainfall data is relatively easy to acquire, but discharge data is normally difficult.

The continuous hydrological data series is necessary for more than 10-years in the water balance calculation of the water resources planning.

Runoff model is to calculate the discharge, and hydrological data such as rainfall is used as input data in the runoff model.

1.1 Purpose of Runoff Calculation

Purpose of runoff calculation is as follows;

- Supplement of discharge data for missing and/or non-gauged periods.
- Presumption of discharge data for non-gauged points.

1.2 Contents of Runoff Calculation

Runoff calculation is put into two categories, one is runoff analysis and another is runoff prediction. Runoff analysis is put into two categories furthermore, one is Identification of parameters and another is verification of parameter.

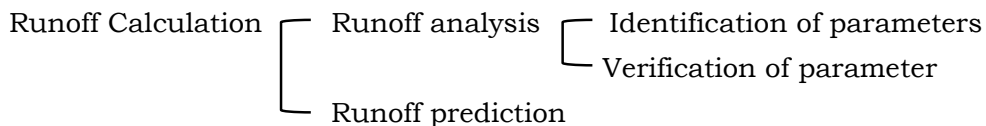

Runoff model consists of some parameters, and parameters are identified by comparing the simulated and observed hydrograph. Furthermore, the calibrated parameters are verified by comparing the hydrographs of different period.

Runoff prediction is the discharge calculation for supposed (e.g. future) conditions of basin or period of no data.

2. DATA

Data is most essential for the design and /or planning. It goes without saying that all of collected data should be carefully examined in advance. It should be considered carefully before the selection of data period/location, because it's not free of charge and it's needed much time to assemble.

2.1 Available Data

2.1.1 Meteorological Data

Meteorological data are mainly observed by National Meteorological Agency (NMA).

Data items which can be collected from NMA are shown as follows.

- Rainfall
- Temperature (maximum and minimum)
- Evaporation
- Wind
- Sunshine Hour
- Relative Humidity

In the low water analysis, the calculation interval is normally one (1) day and daily rainfall data is used, herein.

2.1.2 Hydrological Data

Hydrological (discharge) data is mainly observed by the Ministry of Water, Irrigation and Energy (MoWIE).

2.1.3 Data of Basin Condition

Available data for basin conditions are;

- DEM data
- Soil data
- Geology
- Land Use etc

ASTER DEM which is one of the DEM data can be taken from Web site. Besides, MoWIE has GIS data of soil, geology, land use and so on of each main basin in Ethiopia.

2.2 Data Handling

Following knowledge is useful for assembling the time series data such as hydrological and/or meteorological data.

2.2.1 Hydrological Year

Dry season is from November to February in almost all of the Oromia Region. Then “January” will be considered as the beginning of hydrological year (water year).

2.2.2 Leap Year

Long-term data is usually assembled in daily base, and it is necessary to take into account for the leap year.

A leap year comes every four years, and so in every fourth year February has twenty nine (29) days.

Details of “hydrological year” and “leap year” are described in ANNEX-2.

2.2.3 Boundary of the Day

Collected daily rainfall data from NMSA is observed at 9 AM. In this case, the boundary of the day is 9 AM. When the observation is done by manual, time of observation is usually 9 AM.

But, 0 AM may be selected as the boundary of the day when the automatic equipment is installed.

Selection of “boundary of the day” will cause the difference of the daily rainfall amount.

Detail explanation of the boundary of the day is shown in ANNEX-13.

2.3 Complementation of the Missing Data

2.3.1 Missing Data and Abnormal Data

In period of low water, the discharge variation must be relatively stable and it is unlikely to appear the sudden change in hydrograph.

Figure-2.1 shows the observed hydrograph at Keleta sire Arsi. There is a missing data at 31st of January.

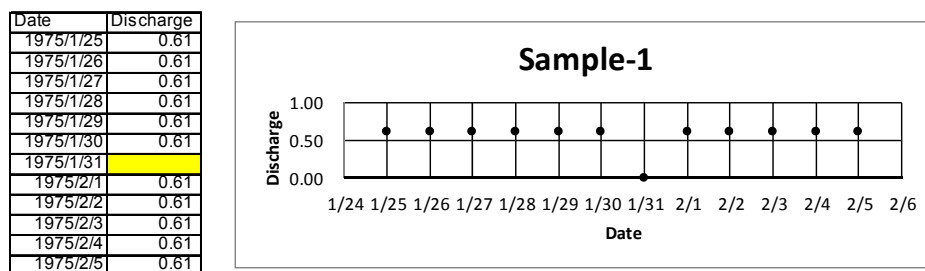

Figure-2.1 Hydrograph at Keleta sire Arsi (Sample-1)

Judging from the trend of hydrograph (Figure-2.1), it is easily understand that the discharge of 31st of January must be 0.61m³/s. There is a singular event at 31st of January in Figure-2.2. This kind of event is difficult to understand in the period of low water as previously mentioned. Therefore, this value should be judged as mistake and should be modified to 0.37m³/s naturally.

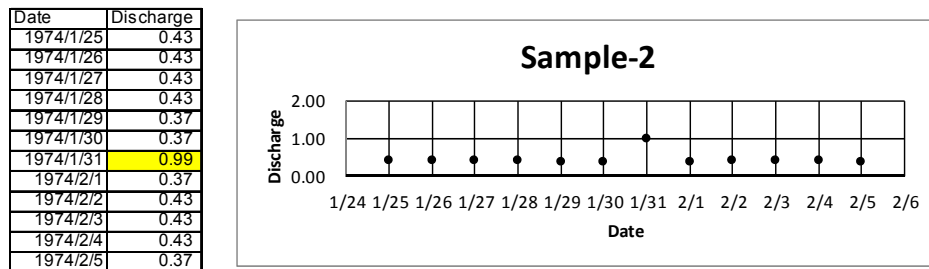

Figure-2.2 Hydrograph at Keleta sire Arsi (Sample-2)

Also, Figure-2.3 shows a missing data 28th of February. In this case, because the values of 27th of February and 1st of March are difference, the value averaged both one is adopted. Herein, the value is 0.338m³/s $((0.367+0.309)/2)$. If the missing data is plural, the procedure is same.

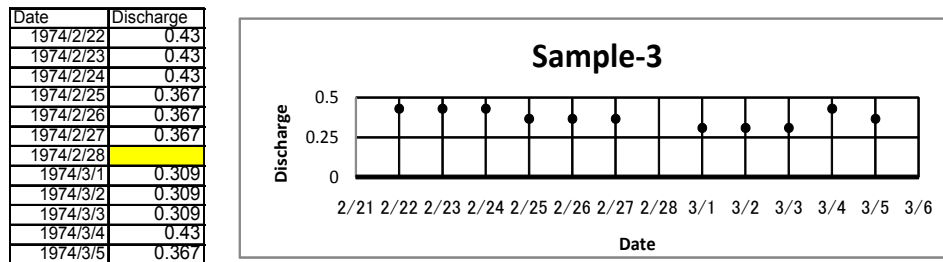

Figure-2.3 Hydrograph at Keleta sire Arsi (Sample-3)

In the hydrograph investigation, the plotting method of log-scale is very useful to see the trend of runoff event. Sample of comparison between normal scale and log scale is shown in ANNEX-16. When we use the normal scale, hydrograph of low water period may be difficult to see. But, when we use the log scale, this extent is emphasized and may be easily to see.

For example, the wrong data around 350 day is easily found in Figure-2.4.

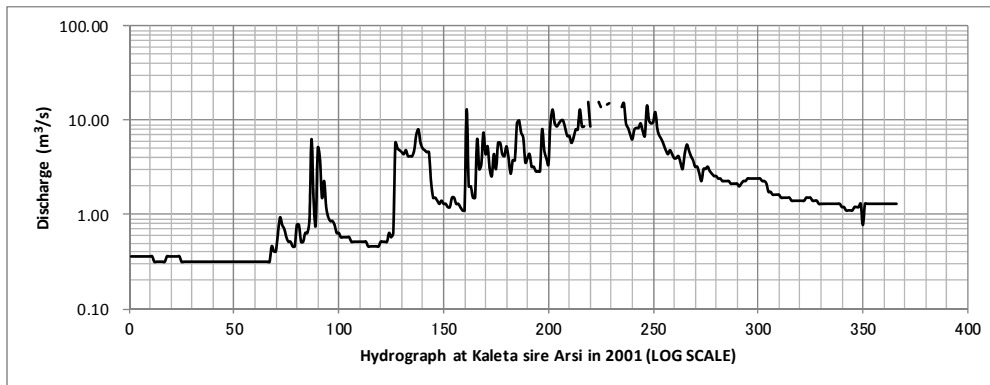

Figure-2.4 Hydrograph at Keleta sire Arsi (2001)

The event of discharge has the characteristics of serial especially in the dry season, but the event of rainfall has the characteristics of instantaneousness. Therefore, the method of modification and/or supplement mentioned herein is unfortunately not able to use about rainfall data.

2.3.2 Ratio of Catchment Area

Discharge data of the non-gauged points may be supposed approximately by using the “ratio of catchment area”, if there is a gauged-station nearby.

In case of similar basin conditions and hydrological characteristics, runoff process may be considered as similar, too.

If there is not much difference (within same order) of the catchment areas, the discharge of non-gauged points may be calculated by using the ration of catchment area.

2.3.3 Correlation

Rainfall/discharge data of any location (point) and/or missing station may be supposed by using the correlation of the station-to-station, if there is a good correlation among the target stations. Details are shown in ANNEX-15.

3. RUNOFF MODEL

There are many types of runoff model which are broadly classified into response model and physical model. Physical model can be further classified into two types which are “Lumped parametric model” and “Distributed parametric model”.

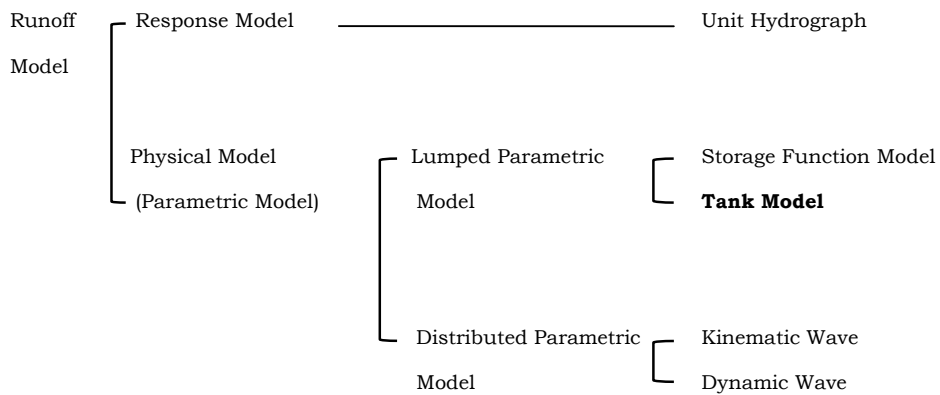

The performance of computer is rapidly improved in recent years and complex mathematical calculation with large capacity is possible to execute in the rainfall-runoff process. The type of physical model is a mainstream currently in the runoff analysis, therefore.

3.1 Response Model

Response model is the type of black box models and does not attempt to explicitly represent the physical processes. This type of model adopts empirical and mathematical equations regarding the physical processes of time series from input to output. The transfer functions are purely derived from the observed datasets and the physical processes are not properly considered.

3.2 Physical Model

Lumped parametric model such as Tank Model is a type of black box, but the procedure of calculation is considerably simple and the efficiency of calculation is excellent.

There are many types of “Distributed parametric models”, such as Stanford Watershed Model IV, the Bought on Model, the APIC Model, the Sacramento Model, the Xinanjiang model, SHE, IHDM, HEC-RAS, SWAT

and etc.

These models are the same in terms of modeling the physical (watershed) flow process in the actual river.

Processing time of computation tends to be long, and the consideration must be given to the stability of the solution.

Distributed parametric model is the runoff model which is divided in three-dimensional basin, and runoff process is treated three-dimensionally and simultaneously in this model. As a result, three-dimensional input data of vegetation, geographical, roughness, permeability coefficient of soil and etc. should be incorporated in the model.

3.3 Selection of Suitable Model

Runoff model should have not only practical accuracy, but also computational efficiency and consistency of the model's structure and available data. For example, the model which takes long assembling time or needs the difficult-to-obtain data is not suitable for the runoff model.

Distributed parametric model requires a lot of input data (detailed 3-dimensional) which are vegetation, topography, roughness coefficient, soil condition, permeability of the soil and so on.

If there is no detailed information of hydrological conditions in the target basins, the distributed parametric model is not satisfied with quantity of data items, therefore.

The simpler model such as lumped model (tank model, etc.) is effective on this case.

4. OBJECTIVES

4.1 Planning Basins

Evaluation points for runoff calculation should be coincided with the planning points of the water resources, and the planning points are mainly the locations of intakes which may be proposed by water resources engineer.

Runoff model is originally set up at the gauging station, but target gauging station is not almost coincided with the planning points.

There are two (2) ways for estimating the hydrograph of the target point, one is “runoff model” and another is “the ratio of catchment area”.

If there is a gauged station in/around the target river system, the discharge data of this gauged station is available to estimate/convert the discharge of planning point by using “the ratio of catchment area”.

If there is no gauge station in/around the target river system, the runoff model calibrated by nearby gauged station is useful to estimate the discharge data.

4.2 Period for Planning

Target period for the water resources planning is mainly depended on the available data period and data quality.

Continuous series (over 10 years) of hydrological data are necessary to make the water resources planning, and target period of water resources planning should be determined by taking into account the situation of the collected data.

5. TANK MODEL

The Tank Model is a conceptual rainfall-runoff model developed by Dr. Sugawara.

This non-linear tank served as a practical hydrological model in many countries and its excellent use was demonstrated by WMO intercomparison project of hydrological models in 1975. He travelled all over the world and calculated hydrographs of many rivers including the Danube, Vistra and the Yangtze. His Tank may be one of the most widely used models in the world especially in Southeast Asia¹.

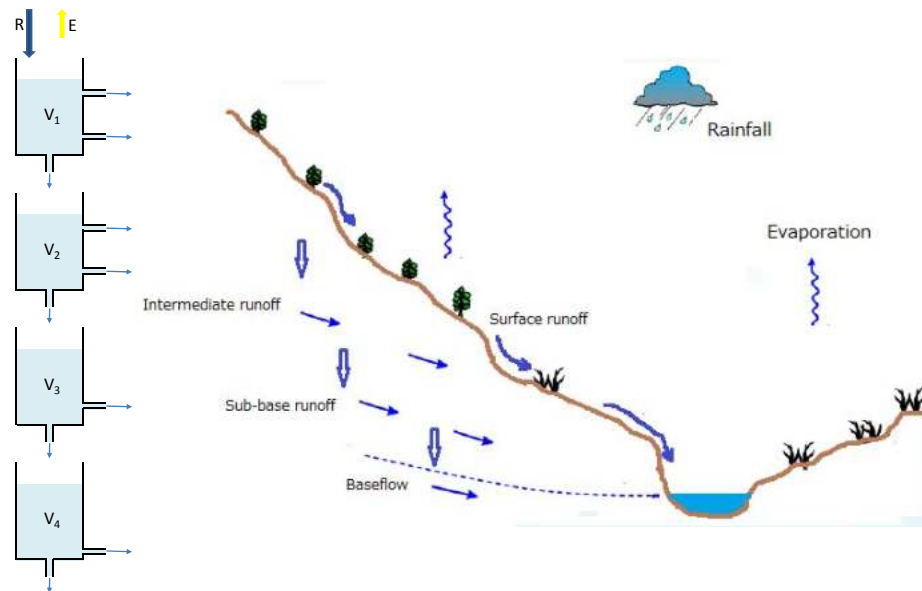

Figure-5.1 Concept of Tank Model

The tank model is a very simple model, composed of four (4) tanks laid vertically in series, and each tank have one (1) or two (2) side outlet(s) for runoff and one bottom outlet for infiltration as shown in Figure-5.1.

Precipitation is put into the top tank, and evaporation is subtracted from the top tank. If there is no water in the top tank, evaporation is subtracted from the second tank; if there is no water in both tanks, evaporation is subtracted from the third tank; and so on.

The outputs from the side outlets are the calculated runoffs. The output

¹ IAHS website (<http://iahs.info/history/obituaries/Sugawara.htm>)

from the top tank is considered as surface runoff, output from the second tank as intermediate runoff, from the third tank as sub-base runoff and output from the fourth tank as base flow. This may be considered to correspond to the zonal structure (so-called aquifer) of underground water shown typically in ANNEX-1.

In spite of its simple outlook, the behavior of the tank model is not so simple.

The tank model can represent many types of hydrograph because of its non-linear structure caused by setting the side outlets somewhat above the bottom of each tank.

The tank model described above is applied to analyze daily discharge from daily rainfall and evaporation inputs.

The concept of initial loss of rainfall is not necessary, because its effect is included in the non-linear structure of the tank model.

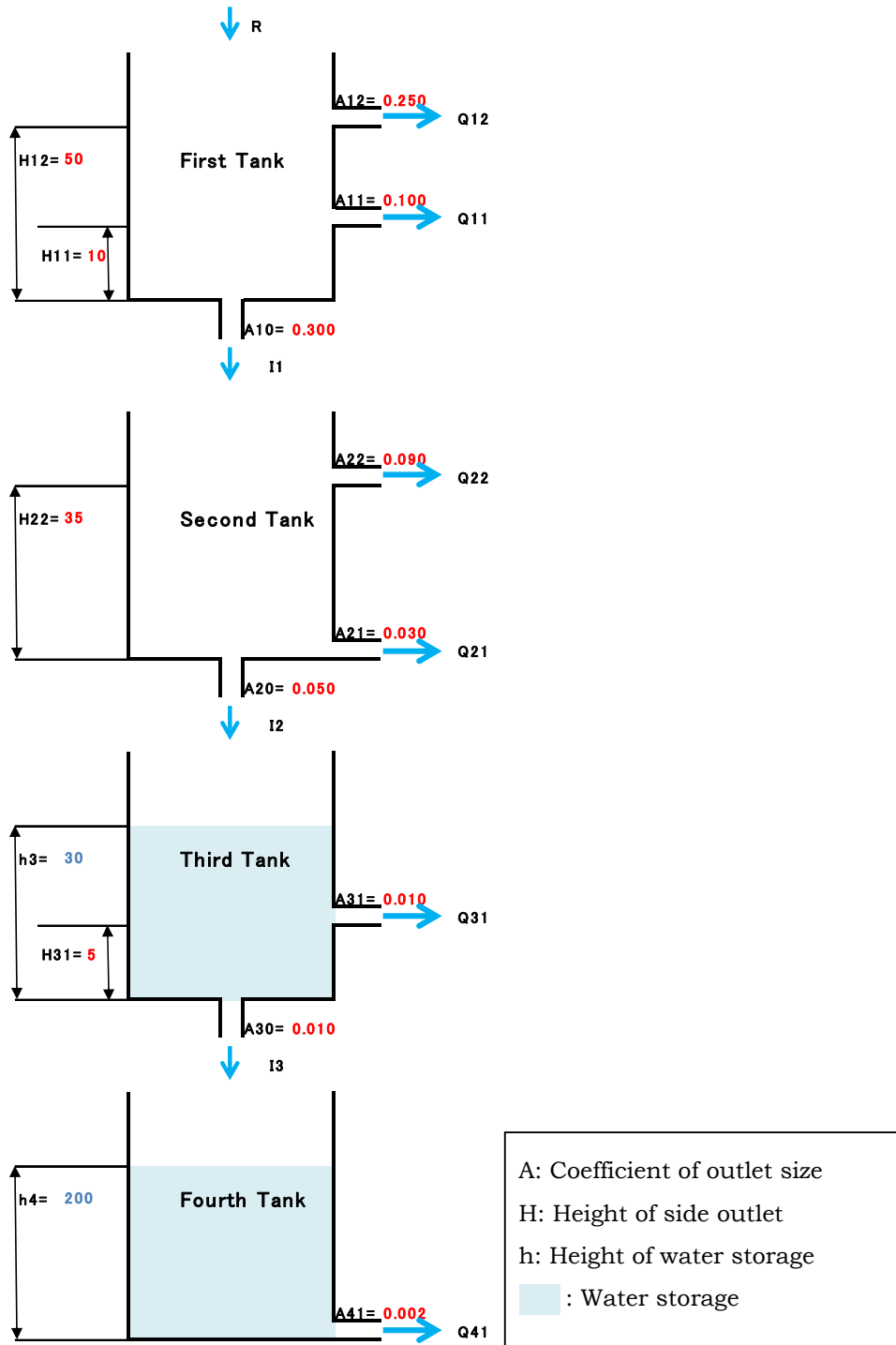

5.1 Outline of Tank Model

The characteristics of tank model are summarized as follows.

- Phenomena in which initial loss and its volume are changed by rainfall hysteresis are automatically included in this model. (side outlets and bottom outlet of first tank)
- Non-linear characteristics that runoff enlarge increasingly with the amount of rainfall is included in this model. (multiple side outlets of first tank)
- When the rainfall intensity is high, storage of first tank increases higher and runoff increases consequently. When the rainfall intensity is low, almost of storage infiltrate to lower tank and outflow becomes slowly. (series system of the tanks)
- Outflow of each tank shows the inherent reduction curves. Therefore, total runoff is calculated as summary of each tank's runoff that has the inherent reduction curve. (combination of multiple tanks)
- When the storage water pass through to the lower tank, the time lag of runoff is automatically added. (series system of the tanks)

5.2 Parameters

Prototype model prepared by Dr. Sugawara is shown in Figure-5.2. There are thirteen (13) parameters in total and details are listed in Table-7.1. The scheme of this prototype is only an example.

It is naturally possible to modify the model's scheme, whenever identification of parameters is difficult or the hydrological condition of the basins is unique.

6. DATA OF TANK MODEL

Time interval for calculation is necessarily one (1) day in the low flow runoff analysis by the tank model. Since the calculation interval is 1 day, it is not able to express a runoff variation in a period of less than one (1) day.

If the event of snowfall is not negligible in/around the target basin, daily temperature data is necessary in the model. But, the event of snowfall is negligible in the Oromia region and the temperature data is not necessary in the model.

6.1 Input Data

Input data of the tank model are as follows:

- Rainfall
- Evapotranspiration

6.1.1 Rainfall

Daily rainfall data is observed in the rain gauge, and these data are called as point rainfall and are not representative of the whole target basin.

If there are several rain gauges in/around the target basin; method of Thiessen polygon² is normally adopted to estimate areal rainfall.

Thiessen polygon is most useful method for estimating the areal rainfall, but rain gauges more than two are essential in the procedure. Thiessen method is mentioned on Annex-6 and Annex-7.

6.1.2 Evapotranspiration and Loss

Evapotranspiration used in the tank model is daily evapotranspiration. This can be calculated by dividing monthly evapotranspiration by the number of days of the month. Evapotranspiration is observed in first class meteorology station of NMA and can be gotten from NMA.

Otherwise, considering the loss between the runoff of river and the rainfall in the river basin, the loss should almost accord with the evapotranspiration but it is not so. Because of this, the evapotranspiration is compensated by the following coefficient to correspond to the actual loss.

$$\text{Eff} = ((\text{annual mean rainfall}) - (\text{annual mean runoff})) / (\text{annual mean evapotranspiration})$$

Eff: Correction coefficient for evapotranspiration used in tank model

²Guideline for Irrigation Master Plan Study Preparation on Surface Water Resources, CBID Project (JICA), May 2014

6.1.3 Initial Storage

Initial storages of each tank should be assumed as one of input data. If runoff calculation starts in season of rainy or snowmelt, the runoff of this period fluctuates considerably large and it is difficult to set up the initial storage of each tank. Runoff calculation should be started at the beginning of the hydrological year, therefore. (that is first of January) In general, there is no storage in the first and second tank in January and initial storage in the third and fourth tank is suggested as follows listed in Table-6.1. Table-6.1 corresponds to Figure-5.2.

Table-6.1 Initial Storage of Each Tank

No.	Series of Tank	Initial Storage
1	(Top) first	0
2	Second tank	0
3	third tank	10-100
4	fourth tank	100-1000

It is useful empirical knowledge that runoff ratio of third and fourth tank is 0.4 and 0.6, respectively in dry season.

6.2 Discharge Data

The used unit in the tank model is “mm/day” and following relation is used to convert to “m³/s” for the basin of A km².

$$Q = q(mm/day) \times \frac{10^{-3}}{86400} \times A(km^2) \times 10^6 = \frac{q \times A}{86.4} (m^3/s)$$

The unit of observed runoff data (daily mean) is “m³/s” and following relation is used to convert to “mm/day” for the basin of A km².

$$q = Q(m^3/s) \times \frac{86.4}{A(km^2)} \times 10^6 = \frac{86.4 \times Q}{A} (mm/day)$$

7. EXAMPLE OF CALCULATION BY TANK MODEL

Example of Tank Model is shown in Figure-5.2 and parameter is listed in Table-7.1.

7.1 Calculation Procedure

Calculation procedure of Tank Model is explained, herein.

Time interval of calculation is one (1) day because purpose of runoff analysis is low water regime.

Procedure of calculation is as follows.

Calculation is performed for each tank from upper to lower, and calculation interval is 1 day.

Storage of top tank is calculated as follow;

$$\text{Storage}_{(t)} = \text{Storage}_{(t-1)} + \text{Rainfall}_{(t-1)} - \text{Evapotranspiration}_{(t)}$$

Herein, $\text{Storage}_{(t-1)}$ is the storage of previous day. $\text{Rainfall}_{(t-1)}$ is the rainfall of the previous day. Also, $\text{Rainfall}_{(t-1)}$ is replaced by $\text{Infiltration}_{(t)}$ from the upper tank for 2nd– 4th tank.

$$\text{Storage}_{(t)} = \text{Storage}_{(t-1)} + \text{Infiltration}_{(t)} (- \text{Evapotranspiration}_{(t)})$$

Evapotranspiration is subtracted from the top tank. If there is no water in the top tank, evapotranspiration is subtracted from the second tank; if there is no water in both the top and the second tank, evapotranspiration is subtracted from the third tank; and so on.

But, if $\text{Rainfall}_{(t-1)}$ is more than 0.5 mm/day, $\text{Evapotranspiration}_{(t)}$ is considered to be half (1/2) .

Outflow from the side outlet(s) and infiltration from the bottom outlet are calculated by the estimated storage height.

Outflow is calculated by the product of the side outlet's coefficient and the height of storage above the outlet. If there are multiple side outlets, the outflow is estimated at total from the side outlets.

Storage height of each tank is finally calculated by subtracting the amount of outflow(s) and infiltration.

7.2 Parameters

Parameters are supposed as shown in Table-7.1. The period of example calculation is set from 1st of Jan. to 6th of Jan., and input data of rainfall and evapotranspiration are shown in Table-7.2.

Herein, model's parameters of the prototype are the number of thirteen (13) and default values are proposed by Dr. Sugawara, shown in Table-7.1.

7.3 Initial Conditions

Initial values of storage are supposed as 20 mm for third tank and 200 mm for fourth tank.

Table-7.1 PARAMETERS AND DEFAULT VALUES

Series	Code	Parameter		Tank
		Content	value	
1	A ₁₀	Coefficient of bottom	0.300	1 st Tank
2	A ₁₁	Coefficient of lower side	0.100	
3	H ₁₁	Height of lower side	10	
4	A ₁₂	Coefficient of upper	0.250	
5	H ₁₂	Height of upper side	50	
6	A ₂₀	Coefficient of bottom	0.050	2 nd Tank
7	A ₂₁	Coefficient of lower side	0.030	
8	A ₂₂	Coefficient of upper	0.090	
9	H ₂₂	Height of upper side	35	
10	A ₃₀	Coefficient of bottom	0.010	3 rd Tank
11	A ₃₁	Coefficient of lower side	0.010	
12	H ₃₁	Height of lower side	5	
13	A ₄₁	Coefficient of lower side	0.002	4 th Tank

Unit : H(mm), A(day⁻¹)

7.4 Input Data

Meteorological data (input data) are assumed as shown in Table-7.2.

Table-7.2 Input Data (Sample)

Data	Rainfall	Evapotranspiration
1999/12/31	0	
2000/1/1	0	0.6
2000/1/2	0	0.6
2000/1/3	0	0.6
2000/1/4	27.5	0.6
2000/1/5	0	0.6
2000/1/6		0.6

unit: mm/day

7.5 Calculation

Details of calculation procedure are as follows.

Table-7.3 Example of Calculation

Day	Series of Tank	Storage (initial)	Output	Storage (result)
1/1/2012	1-st	$S1=S1+R-E=0+0-0.6=-0.6<0$: therefore $S1=0$ E is not subtracted from S1, so E will be subtracted from 2-nd tank.	$S1=0$, then $Q11=0$, $Q12=0$ and $I1=0$	$S1=S1-Q11-Q12-I1=0$
	2-nd	$S2=S2+I1-E=0+0-0.6=-0.6<0$: therefore $S2=0$ E is not subtracted from S2, so E will be subtracted from 3-rd tank.	$S2=0$, then $Q21=0$, $Q22=0$ and $I2=0$	$S2=S2-Q21-Q22-I2=0$
	3-rd	$S3=S3+I2-E=20+0-0.6=-19.4$	$S3=19.4$, then $Q31=(19.4-5)x0.01=0.144$ and $I3=19.4x0.01=0.194$	$S3=S3-Q31-I3$ $=19.4-0.144-0.194=19.062$
	4-th	$S4=S4+I3-E=200+0.194-0=200.194$: E is subtracted from 3-rd tank, then $E=0$.	$S4=200.194$, then $Q41=200.194x0.002=0.400$ Total output = $Q11+Q12+Q21+Q22+Q31+Q41=0+0+0.144+0.400=0.544$	$S4=S4-Q41$ $=200.194-0.4=199.794$
1/2/2012	1-st	$S1=S1+R-E=0+0-0.6=-0.6<0$: therefore $S1=0$ E is not subtracted from S1, so E will be subtracted from 2-nd tank.	$S1=0$, then $Q11=0$, $Q12=0$ and $I1=0$	$S1=S1-Q11-Q12-I1=0$
	2-nd	$S2=S2+I1-E=0+0-0.6=-0.6<0$: therefore $S2=0$ E is not subtracted from S2, so E will be subtracted from 3-rd tank.	$S2=0$, then $Q21=0$, $Q22=0$ and $I2=0$	$S2=S2-Q21-Q22-I2=0$
	3-rd	$S3=S3+I2-E=19.062+0-0.6=18.462$	$S3=18.462$, then $Q31=(18.462-5)x0.01=0.135$ and $I3=18.462x0.01=0.185$	$S3=S3-Q31-I3$ $=18.462-0.135-0.185=18.142$
	4-th	$S4=S4+I3-E=199.794+0.185-0=199.979$: E is subtracted from 3-rd tank, then $E=0$.	$S4=199.979$, then $Q41=199.979x0.002=0.400$ Total output = $Q11+Q12+Q21+Q22+Q31+Q41=0+0+0.135+0.400=0.535$	$S4=S4-Q41$ $=199.979-0.4=199.579$
1/3/2012	1-st	$S1=S1+R-E=0+0-0.6=-0.6<0$: therefore $S1=0$ E is not subtracted from S1, so E will be subtracted from 2-nd tank.	$S1=0$, then $Q11=0$, $Q12=0$ and $I1=0$	$S1=S1-Q11-Q12-I1=0$
	2-nd	$S2=S2+I1-E=0+0-0.6=-0.6<0$: therefore $S2=0$ E is not subtracted from S2, so E will be subtracted from 3-rd tank.	$S2=0$, then $Q21=0$, $Q22=0$ and $I2=0$	$S2=S2-Q21-Q22-I2=0$
	3-rd	$S3=S3+I2-E=18.142+0-0.6=17.542$	$S3=17.542$, then $Q31=(17.542-5)x0.01=0.125$ and $I3=17.542x0.01=0.175$	$S3=S3-Q31-I3$ $=17.542-0.125-0.175=17.242$
	4-th	$S4=S4+I3-E=199.579+0.175-0=199.754$: E is subtracted from 3-rd tank, then $E=0$.	$S4=199.754$, then $Q41=199.754x0.002=0.400$ Total output = $Q11+Q12+Q21+Q22+Q31+Q41=0+0+0.125+0.400=0.525$	$S4=S4-Q41$ $=199.754-0.4=199.354$
1/4/2012	1-st	$S1=S1+R-E=0+0-0.6=-0.6<0$: therefore $S1=0$ E is not subtracted from S1, so E will be subtracted from 2-nd tank.	$S1=0$, then $Q11=0$, $Q12=0$ and $I1=0$	$S1=S1-Q11-Q12-I1=0$
	2-nd	$S2=S2+I1-E=0+0-0.6=-0.6<0$: therefore $S2=0$ E is not subtracted from S2, so E will be subtracted from 3-rd tank.	$S2=0$, then $Q21=0$, $Q22=0$ and $I2=0$	$S2=S2-Q21-Q22-I2=0$
	3-rd	$S3=S3+I2-E=17.242+0-0.6=16.642$	$S3=16.642$, then $Q31=(16.642-5)x0.01=0.116$ and $I3=16.642x0.01=0.166$	$S3=S3-Q31-I3$ $=16.642-0.116-0.166=16.360$
	4-th	$S4=S4+I3-E=199.354+0.165-0=199.520$: E is subtracted from 3-rd tank, then $E=0$.	$S4=199.520$, then $Q41=199.520x0.002=0.399$ Total output = $Q11+Q12+Q21+Q22+Q31+Q41=0+0+0.116+0.399=0.515$	$S4=S4-Q41$ $=199.520-0.399=199.121$
1/5/2012	1-st	$S1=S1+R-E=0+27.5-0.6*0.5=-27.2$: $R>0.5$, therefore $E=0.6x0.5=0.3$	$S1=27.20$: $S1<50$, then $Q11=0$: $Q12=(27.20-10)x0.10=1.720$: $I1=27.2x0.3=8.16$	$S1=S1-Q11-Q12-I1$ $=27.20-0-1.72-8.16=17.32$
	2-nd	$S2=S2+I1-E=0+8.16-0=8.16$ E was subtracted from 1-st tank, therefore $E=0$.	$S2=8.160$: $S2<35$, then $Q21=0$: $Q22=8.160x0.03=0.245$ and $I2=8.160x0.05=0.408$	$S2=S2-Q21-Q22-I2$ $=8.160-0-0.245-0.408=7.507$
	3-rd	$S3=S3+I2-E=16.380+0.408-0=16.788$	$S3=16.788$, then $Q31=(16.788-5)x0.01=0.118$ and $I3=16.788x0.01=0.168$	$S3=S3-Q31-I3$ $=16.788-0.118-0.168=16.482$
	4-th	$S4=S4+I3-E=199.121+0.168-0=199.289$	$S4=199.289$, then $Q41=199.289x0.002=0.399$: Total output = $Q11+Q12+Q21+Q22+Q31+Q41$ $=0+1.720+0+0.245+0.118+0.399=2.482$	$S4=S4-Q41$ $=199.289-0.399=198.890$
1/6/2012	1-st	$S1=S1+R-E=17.32+0-0.6=-16.72$	$S1=16.72$: $S1<50$, then $Q11=0$: $Q12=(16.720-10)x0.10=0.6720$: $I1=16.72x0.3=5.016$	$S1=S1-Q11-Q12-I1$ $=16.72-0-0.672-5.016=11.032$
	2-nd	$S2=S2+I1-E=7.507+5.016-0=12.523$ E was subtracted from 1-st tank, therefore $E=0$.	$S2=12.523$: $S2<35$, then $Q21=0$: $Q22=12.523x0.03=0.376$ and $I2=12.523x0.05=0.626$	$S2=S2-Q21-Q22-I2$ $=12.523-0-0.376-0.626=11.521$
	3-rd	$S3=S3+I2-E=16.482+0.626-0=17.108$	$S3=17.108$, then $Q31=(17.108-5)x0.01=0.121$ and $I3=17.108x0.01=0.171$	$S3=S3-Q31-I3$ $=17.108-0.121-0.171=16.816$
	4-th	$S4=S4+I3-E=198.890+0.171-0=199.061$	$S4=199.061$, then $Q41=199.061x0.002=0.398$: Total output = $Q11+Q12+Q21+Q22+Q31+Q41$ $=0+0.672+0+0.376+0.121+0.398=1.567$	$S4=S4-Q41$ $=199.061-0.398=198.663$

S: Storage R: Rainfall E: Evapotranspiration I: Infiltration

8. IDENTIFICATION PROCEDURE AND VERIFICATION OF TANK MODEL

In tank model, all of the runoff components that are surface, intermediate, sub-groundwater and groundwater are simultaneously considered in the identification of model parameters.

Each tank has one or two side outlet(s) and one bottom outlet, and coefficients of outlets and heights of outlets are identified so as to simulate the observed hydrograph with the adequate accuracy.

The Tank Model, (Sugawara, et. al., 1983), with four vertical tanks is used in this manual. The side outputs from the top tank, second tank, third tank and the bottom tank represent surface runoff, intermediate runoff, sub-base runoff and base flow respectively. The structure of the Tank Model with four vertical tanks is shown in Figure-5.2.

Table-8.1 Characteristics of Runoff Components

No.	Series of Tank	Component of Runoff	Duration of Components
1	(Top) first tank	Surface Runoff	1-few days
2	Second tank	Intermediate	10 days
3	third tank	Sub-base Flow	few months
4	fourth tank	Base Flow	years

The tank model is non-linear, and mathematics is nearly useless for non-linear problems. Therefore, the only solution of this problem is to use the trial and error method of numerical calculation.

Component of runoff are classified following four (4) categories and shown in Figure-8.1.

8.1 Data Periods for Evaluation

Available data sets will be split into two (2) periods, one is for model calibration and another is model verification. The ratio of period division is roughly half-and half in general, but will be depend on the data conditions.

- ① Surface runoff
- ② Intermediate Runoff
- ③ Sub-base Flow
- ④ Base Flow

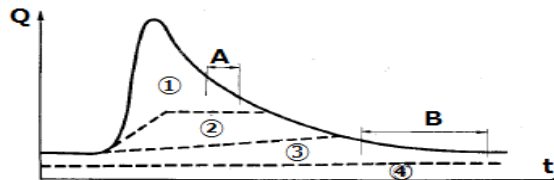

Figure-8.1 Runoff Components

8.2 Identification Procedure

Identification procedure of model parameters is as follows, with comparing of the observed and the simulated hydrograph.

- When you want to modify the flood (surface runoff), you should change the side outlet(s) parameters of first tank.
- When you want to modify the flood foot (intermediate runoff), you should change the side outlet(s) parameters of second tank and/or the infiltration parameter of first tank.
- When you want to modify the low water (sub-base and/or base flow), you should change the side outlet(s) parameters of third/forth tank and/or the infiltration parameters of second/third tank.

Modification of parameters (especially infiltration outlet) will cause the storage change of lower tank and the runoff from the lower tank will be changed. As a result, the parameters of lower tank may be modified.

Efficient order of the parameter identification is as follows:

- i. Modification of first (top) tank**
- ii. Modification of fourth tank**
- iii. Modification of second and third tank**

8.2.1 Characteristics of Parameter in General

The characteristics of parameters in general are listed as follows.

- Generally, the parameters of outlets should become smaller as it goes down.
- The parameters of lower side and infiltration outlet are empirically considered as similar order.

8.2.2 Characteristics of Parameter on Inter-Tank

The characteristics of parameters on inter-tank (relationships between one tank and another) are listed as follows.

- If there are several outlets in the one (1) tank, parameter of upper outlet should be greater than or equal to the lower one.
- The parameters of the second tank are almost medium value between first tank and third tank.
- The parameters of the fourth tank are one order smaller than third tank.

8.2.3 Adjustment of Parameter for Each Component

Dr. Sugawara described about the calibration procedure of the parameters (refer to Water Resources Research³).

- When the outlet coefficients are modified, the slope of hydrograph is changed. The more outlet coefficient enlarges, the steeper hydrograph is shaped.
- When the outlet heights are modified, the shape of hydrograph is shifted down or up. The upper the outlet height is, the lower the hydrograph is. This tendency is typical in the rising part of hydrograph and limited at the tanks except (top) first tank.

Modification procedure of each parameter is illustrated as followings (Figure-8.1) and these hydrograph show the one component only.

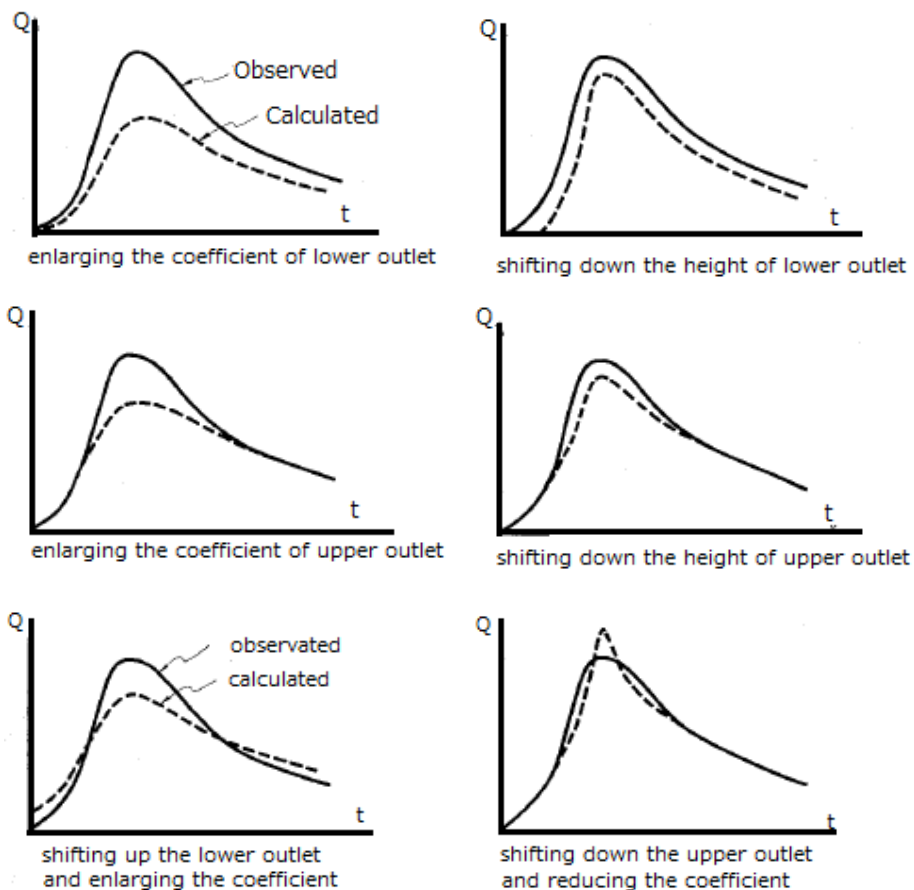

³http://www.cof.orst.edu/cof/fe/watershd/fe537/labs_2007/Catchment_scale/RR-Model/TankModel.pdf

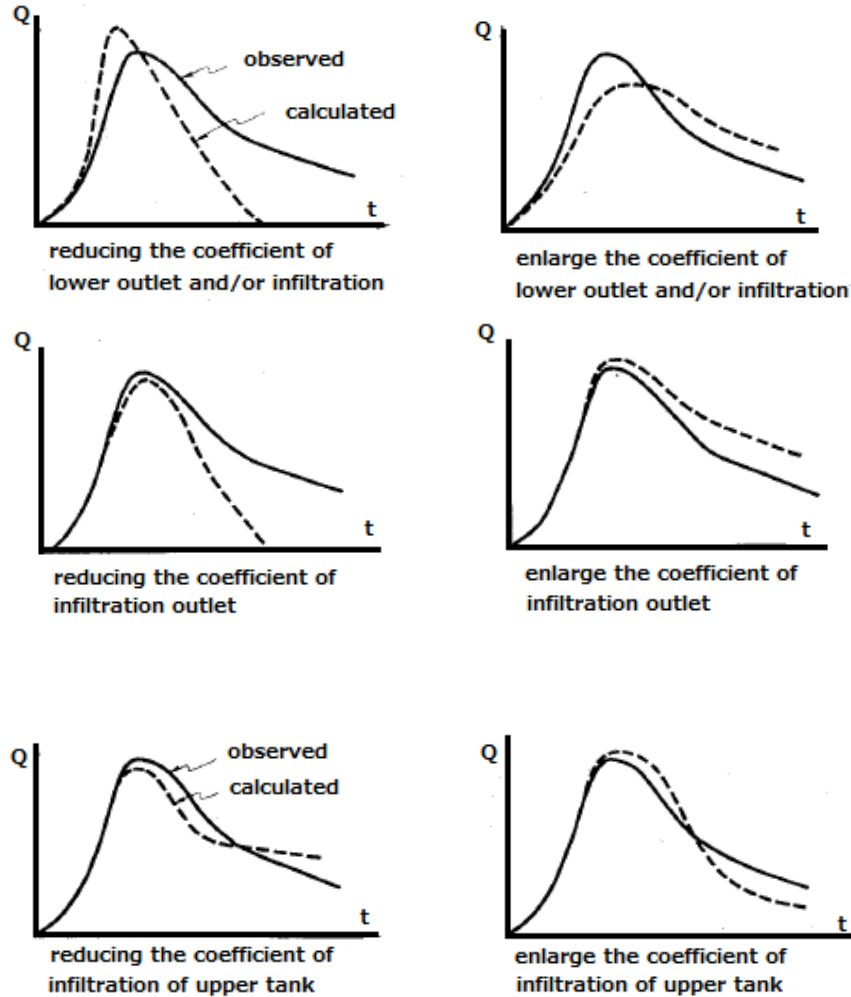

Figure-8.1 Procedure of Calibration for Each Component

8.3 Verification

Runoff model is demanded to duplicate the actual hydrograph with a reasonable accuracy and the verification is necessary to confirm the identified parameters.

The degree of accuracy of parameter estimates was assessed by applying the model to different data set that was not used for calibration.

There are several criteria for evaluating the validity of the model, one is “the least square method” and another is “eyesight method”.

The optimized parameters are evaluated by the comparison of observed and calculated hydrograph. The correlation coefficient which is estimated by “the least square method” is one of the most useful methods for the verification, but the fitness about flood event and low water event are

equally treated in this method.

The project of water resources is mainly aimed to the low water event, therefore we will focus on the low water period of hydrograph. From the point of view, “eyesight method” is effective and user-friendly. ”Eyesight method” is comparing observed and calculated data on the hydrograph by your eyes.

ANNEX-1: CONCEPT OF RUNOFF FROM TANK

Most simple tank is shown in Figure as sample. Outflow from the side outlet is calculated as follow.

$$q(t) = h(t) \cdot \lambda \quad (1)$$

Herein; $h(t)$ is tank's water depth (mm)

λ is outlet coefficient (-)

$q(t)$ is outflow (mm)

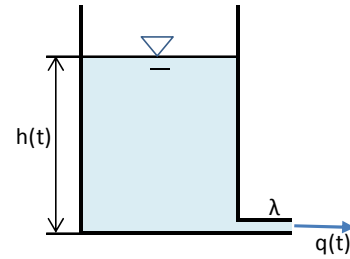

If there is no input from rainfall or upper tank, relationships of continuity is as follow.

$$-q(t) = \frac{dh}{dt} \quad (2)$$

From equation (1) and (2), solution is as follow.

$$q(t) = q_0 \cdot e^{-\lambda t} \quad (3)$$

Herein; q_0 is initial $q(t)$

Equation (3) means that outflow from tank shows the exponential reduction. This tendency of exponential reduction is shown in the actual runoff phenomena.

ANNEX-2: HYDROLOGICAL YEAR AND LEAP YEAR

Hydrological Year

A water year is term commonly used in hydrology to describe a time period of 12 months. It is defined as the period between October 1st of one year and September 30th of the next in U.S.A.

Use of water year as a standard follows the US national water supply data publishing system that was started in 1913. This time interval is often used by hydrologists because hydrological systems in the northern hemisphere are typically at their lowest levels near October 1. The increased temperatures and generally drier weather patterns of summer give way to cooler temperatures, which decreases evaporation rates. Rain and snow replenish surface water supplies.

Examples of how water year is used:

- Used to compare precipitation from one water year to another.
- Used to define a period of examination for hydrologic modeling purposes.
- Used in reports by the United States Geological Survey (USGS) as a term that deals with surface-water supply.

Leap Year

A leap year comes every four years, and so in every fourth year February has twenty nine (29) days.

In the Gregorian calendar, the current standard calendar in most of the world, most years that are integer multiples of 4 are leap years. In each leap year, the month of February has 29 days instead of 28. Adding an extra day to the calendar every four years compensates for the fact that a period of 365 days is shorter than a solar year by almost 6 hours. This calendar was first used in 1582.

Some exceptions to this rule are required since the duration of a solar year is slightly less than 365.25 days. Years that are integer multiples of 100 are not leap years, unless they are also integer multiples of 400, in which case they are leap years. For example, 1600 and 2000 were leap years, but 1700, 1800 and 1900 were not. Similarly, 2100, 2200, 2300, 2500, 2600, 2700, 2900 and 3000 will not be leap years, but 2400 and 2800 will be.

ANNEX-3: EVAPORATION DATA

Evaporation data is observed by NMA (National Meteorological Agency) and monthly mean evaporation is summarized.

	Jan	Feb	Mar	Apr	May	Jun	Jul	Aug	Sep	Oct	Nov	Dec	Total
1988	-	-	-	196.4	345.7	269.9	223.2	138.2	117.1	189.6	228.0	198.4	-
1989	189.9	144.9	192.0	119.5	250.7	204.0	206.7	157.3	125.4	204.2	188.8	106.0	2089.4
1990	180.0	70.2	85.2	129.1	239.9	291.4	160.6	148.6	143.6	233.1	202.5	227.0	2111.2
1991	209.4	146.3	182.5	214.4	248.5	306.8	212.5	157.7	179.7	254.8	237.8	212.7	2563.1
1992	129.0	92.9	237.7	218.9	258.9	310.7	207.9	140.9	118.9	164.8	168.7	89.3	2138.6
1993	122.6	99.9	276.6	144.4	95.6	229.0	223.2	172.7	134.5	149.5	209.4	207.6	2065.0
1998	-	146.0	172.7	257.5	279.6	300.3	223.6	140.5	114.0	154.1	206.4	280.4	2275.1
1999	262.3	346.7	212.4	348.0	389.7	327.7	212.4	170.7	147.7	133.6	229.4	228.3	3008.9
2000	278.0	333.2	376.0	281.0	291.2	340.8	246.0	197.3	157.6	115.4	170.6	196.7	2983.8
2001	180.5	225.6	175.9	250.4	258.9	267.0	199.1	146.0	138.9	192.1	223.3	178.7	2436.4
2002	149.5	260.0	219.7	264.9	338.0	342.5	316.6	218.3	196.6	255.9	-	-	-
2003	202.0	247.4	281.8	255.8	414.5	-	-	-	-	-	-	-	-
2004	-	-	-	170.0	387.0	281.7	-	-	-	-	-	-	-
Mean	190.3	192.1	219.3	219.3	292.2	289.3	221.1	162.6	143.1	186.1	206.5	192.5	2514.3

The monthly evapotranspiration data at the Abomssa is observed by the NMA during from 1988 to 2004 and monthly mean pattern is shown below.

Monthly Mean Observed Evaporation at ABOMSSA (ARSI) : 1988-2004 unit: mm

	Jan	Feb	Mar	Apr	May	Jun	Jul	Aug	Sep	Oct	Nov	Dec	Total
Evaporation	190.3	192.1	219.3	219.3	292.2	289.3	221.1	162.6	143.1	186.1	206.5	192.5	2514.3

Monthly Evaporation

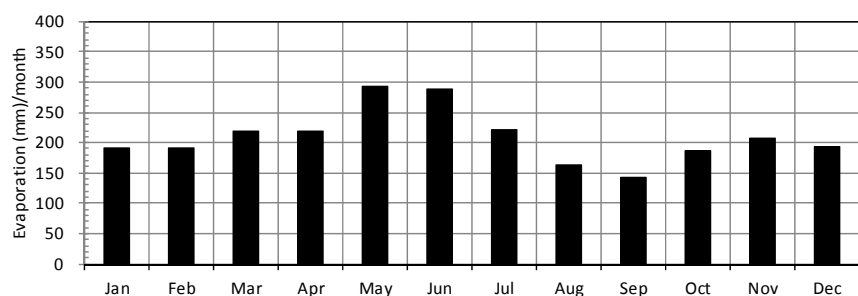

Daily Evaporation for Each Month unit: mm/day

	Jan	Feb	Mar	Apr	May	Jun	Jul	Aug	Sep	Oct	Nov	Dec
Evaporation	6.1	6.9	7.1	7.3	9.4	9.6	7.1	5.2	4.8	6.0	6.9	6.2

Monthly Pattern of Evaporation

ANNEX-4: LOSS

YEAR	Annual Rainfall	Annual Runoff
1990	1000	500
1991	1300	700
1992	900	440
1993	850	370
1994	950	400
1995	1100	545
1996	1150	560
1997	1050	470
1998	890	310
1999	1250	565
2000	920	450
Average	1033	483

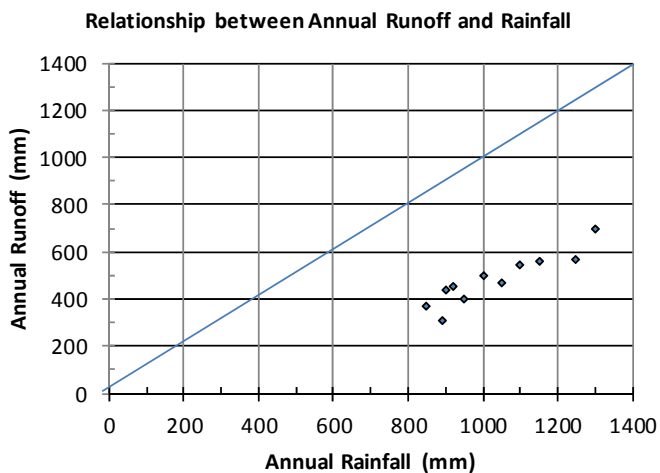

Example of Relationships between Annual Runoff and Annual Rainfall

ANNEX-5: ArcSWAT

ArcSWAT Model is one of the SWAT models that are running on the ArcMAP manufactured by ESRI, and SWAT (Soil and Water Assessment Tool) model is a stand-alone model, which has been under development in the U.S. Department of Agriculture since the 1980s.

The ArcSWAT⁴ ArcGIS extension is a graphical user interface for the SWAT model (Arnold et al., 1998). SWAT is a river basin, or watershed, scale model developed to predict the impact of land management practices on water, sediment, and agricultural chemical yields in large, complex watersheds with varying soils, land use, and management conditions over long periods of time.

SWAT can be used to simulate a single watershed or a system of multiple hydrologically connected watersheds. Each watershed is first divided into sub-basins and then in hydrologic response units (HRUs) based on the land use and soil distributions.

Type of Model

The model is physically based and computationally efficient, uses readily available inputs and enables users to study long-term impacts.

Input Data

The interface requires the designation of land cover/use, soil, weather, groundwater, water use, management, soil chemistry, pond, and stream water quality data, as well as the simulation period, in order to ensure a successful simulation.

The categories specified in the land cover/land use map will need to be reclassified into SWAT land cover/plant types.

Land use and vegetation

Soil

Meteorological

(rainfall, temperature max/min, wind velocity, radiation and humidity)

⁴ ARCSWAT INTERFACE FOR SWAT 2009 USER'S GUIDE, M. WINCHELL, R. SRINIVASAN, M. DI LUZIO, J. ARNOLD, AUGUST, 2010

ANNEX-6: THIESSEN POLYGON

Also known as 'Voronoi networks' and 'Delaunay triangulations', Thiessen polygons were independently discovered in several fields of study, including climatology and geography. They are named after a climatologist used them to perform a transformation from point climate stations to watersheds.

Thiessen polygons can be used to describe the area of influence of a point in a set of points. If you take a set of points and connect each point to its nearest neighbor, you have what's called a triangulated irregular network (TIN).

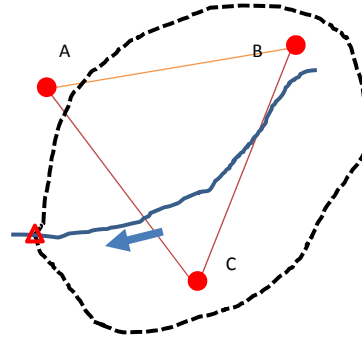

If you bisect each connecting line to segment perpendicularly and create closed polygons with the perpendicular bisectors, the result will be a set of Thiessen polygons.

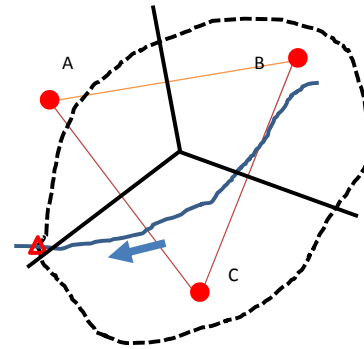

The climate station contained in each polygon represents the rainfall of the polygon.

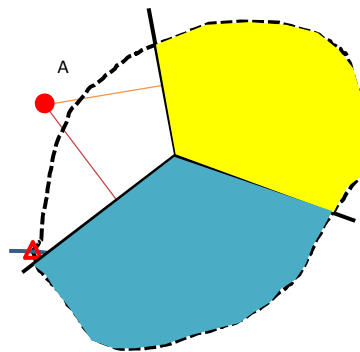

ANNEX-7: EXAMPLE OF THIESSEN COEFFICIENT

Thiessen coefficient means the ratio of area. For example, Thiessen coefficient of a station is a ratio of the area dominated by A station (green area in right sample figure) against the total area.

Sample figure shows the case of three (3) stations.

Accumulative areas of A, B, and C are measured 5 km², 3km² and 2km², respectively and total area is 10 km².

Then, Thiessen coefficients of each station are 0.5 (=5/10), 0.3 (=3/10) and 0.2 (=2/10), respectively.

If there is no data at C station, Thiessen coefficient should be modified using the data of A and B station.

Using the revised Thiessen polygon, dominant areas of A and B are measured 4 km² and 6km², respectively and total area is 10 km². Then, Thiessen coefficients of each station are 0.6 (=6/10) and 0.4 (=4/10), respectively.

If there is no data at A station, Thiessen coefficient should be modified using the data of B and C station.

Using the revised Thiessen polygon, dominant areas of B and C are measured 5 km² and 5km², respectively and total area is 10 km². Then, Thiessen coefficients of each station are 0.5 (=5/10) and 0.5 (=5/10), respectively.

Other cases are not mentioned herein, but listed as follow.

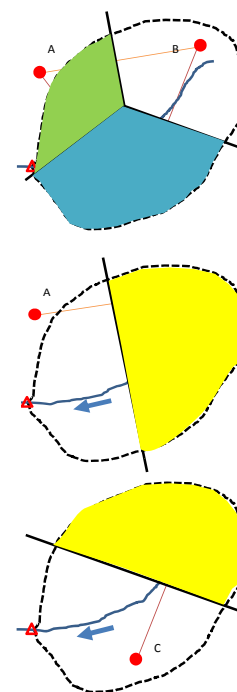

Example of Thiessen Coefficient for Each Case

	A	B	C	Total
case-1	0.5	0.3	0.2	1.0
case-2	-	0.4	0.6	1.0
case-3	-	-	1.0	1.0
case-4	-	1.0	-	1.0
case-5	0.5	-	0.5	1.0
case-6	1.0	-	-	1.0
case-7	0.6	0.4	-	1.0

If there are no data (A, B and C), Thiessen coefficient is not able to be defined.

ANNEX-8: MEASUREMENT OF AREA

Excel file of “Measure of Area” is the tool of measuring the area and/or perimeter of the target.

A sample procedure of area measurement by EXCEL is shown as followings.

1. Open the file of “Measure of Area.xls”
2. Go to **Insert** tool then select **picture**, then go to the folder where you put scanned picture in the form of (JPEG, GIF, TIFF,BMP), then **Insert**

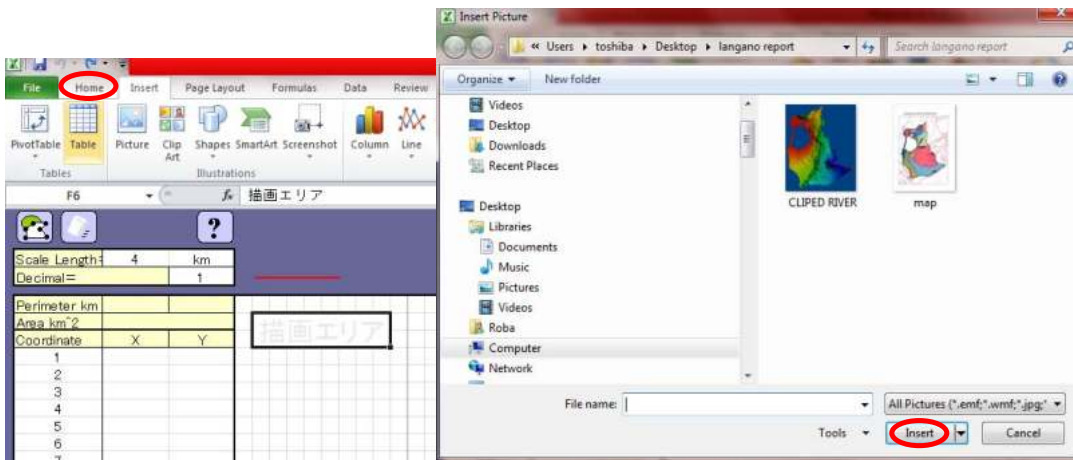

3. If you want to change picture, use “**erase icon**”, then go to the above step

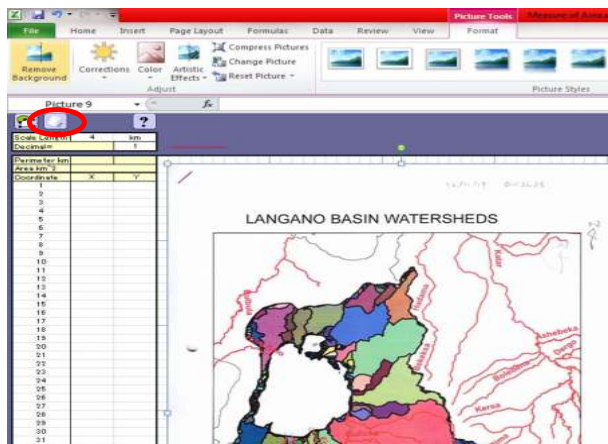

4. Go to the red line and drag and drop to scale bar and match with it as shown above by arrow and write scale bar dimension on excel.

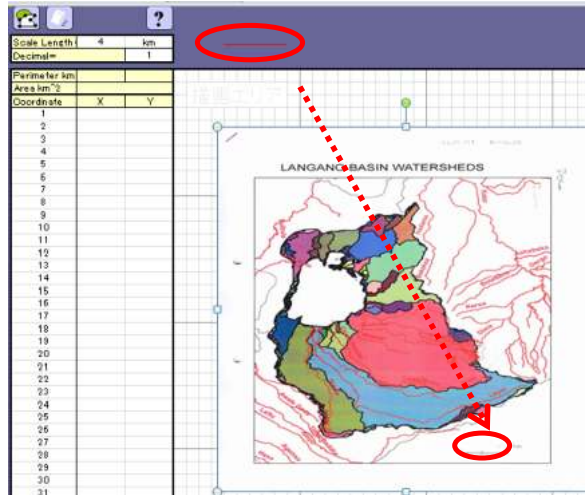

- Go to **Insert**, then **shape**, then select “**free form**”, then draw polygon, then **Format** comes, then select **line weight** then go **edit shape** then edit your shape as you like to fit exact picture.

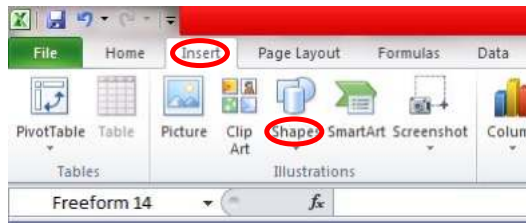

- Click this  icon, then automatically calculates area and perimeter and also coordinates.

Scale Length: 4 km		
Decimal: 1		
Perimeter km		
Area km ²		
Coordinate	X	Y
1	22.1	44.6
2	21.9	44.1
3	22.2	42.1
4	21.7	41.0
5	21.2	39.9
6	20.1	39.6
7	19.5	38.9
8	18.0	37.2
9	17.2	35.7
10	17.0	34.6

ANNEX-9: ARF (AREAL REDUCTION FACTOR)

Daily rainfall data is observed in the rain gauge. These data are observed at a particular point and are not representative of the whole target basin. In general, relationship between the point rainfall and the areal rainfall has tendency shown in below and the function of relationships is called the areal reduction factor (ARF)⁵.

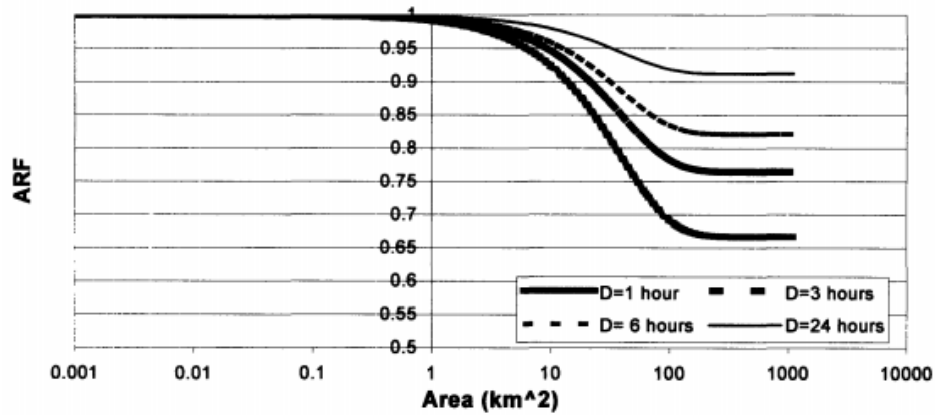

Areal Reduction Factor

⁵The Areal Reduction Factor (ARF) a Multifractal Analysis, Andreas Langousis, 2003

ANNEX-10: CONDITION OF DATA OBSERVATION

The accuracy of discharge simulated by hydrological runoff model is absolutely depended on the accuracy of input data.

Therefore, investigation about available hydrological data is very important component in deciding the adopted model.

Rainfall

Maintenance of rainfall station shown in right picture may be insufficient and the accuracy of observed data may be uncertain.



Good



Bad

Discharge Data

Exposures of rocks are remarkable around the gauging stations shown in picture (right) and then it is very difficult to observe the velocities of river flow and profiles of river cross sections.

Considering to the river bed condition around the gauging station, the observation of flow velocity seems to be difficult not only flooding, but also low flow regime. As a result, reliability of H-Q relationships may not be expected, herein.



ANNEX-11: H-Q RELATIONSHIP

In general, the water level data is observed continuously, but the discharge data is impossible to observe continuously.

Formula of H-Q Relationships (so called, H-Q curve) is the method for the converting from the observed water level to discharge data, and a quadratic curve ($y = ax^2+bx+c$) is normally used in the natural river conditions.

The discharge data corresponding to the water level is observed by “current meter method” (refer to Guideline for Irrigation Master Plan Study Preparation on Surface Water Resources, CBID Project (JICA), 2014).



This method depends on the assumption that the relationships of water level data (H) and discharge data (Q) are one-to-one correspondence in target period.

Procedure of the formulation of H-Q relationship is as follows.

Discharge observation is normally executed once a day in the period of low water, because there is few daily variation of water level in this season. Discharge observation in the rainy season (flooding) is difficult and dangerous because of the flood runoff.

For the purpose of low water analysis (such as water resources calculation), flood hydrograph is not so important, therefore the H-Q relation during the flood is less significant and it will be allowable to some extent.

Date	Water Depth (m)	Observed Discharge (m ³ /s)
10-Nov.-2011	0.21	0.24
20-Dec.-2011	0.15	0.13
01-Jan.-2012	0.12	0.11
15-Feb.-2012	0.48	0.65
30-Mar.-2012	0.55	0.87
05-Apr.-2012	0.34	0.33
15-Apr.-2012	1.45	4.75
13-Aug.-2012	1.29	3.88
05-Sep.-2012	1.54	5.52

In high water, H-Q relationship between water level (H) and discharge (Q) is not able to be decided accurately, and the procedure of extrapolation is needed additionally.

Sample data is listed in Table (numbers of sample are nine) and plotting positions of observed data are shown in Figure.

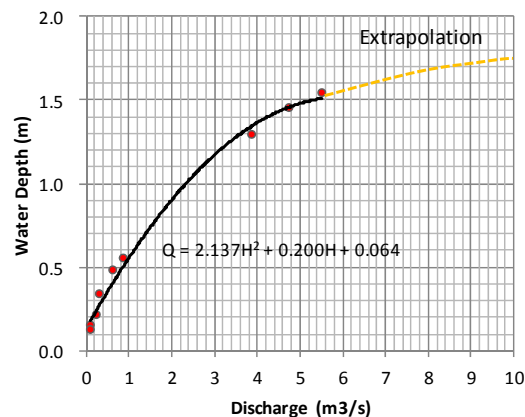

Procedure of analysis depends on “EXCEL” and details are shown as follows.

1. Open the file recording observed water level and discharge.
Make the data table shown in forward and select the extent of data range.

2. Go to “Insert” tab, then select “Scatter”, then select “Scatter with only markers”.

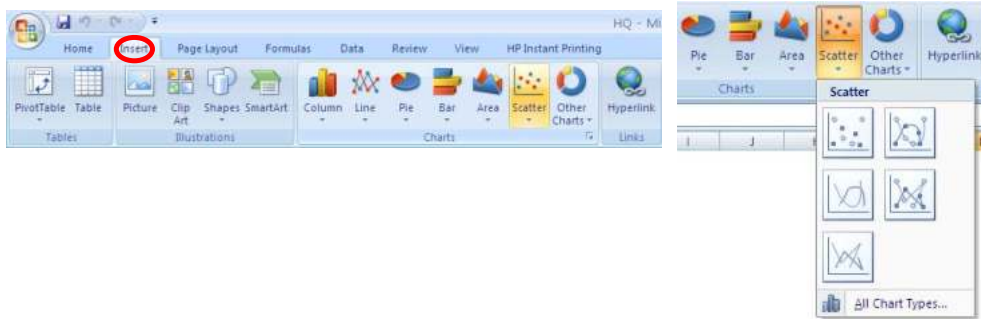

3. Select plotting data on the scatter graph, and then right click.

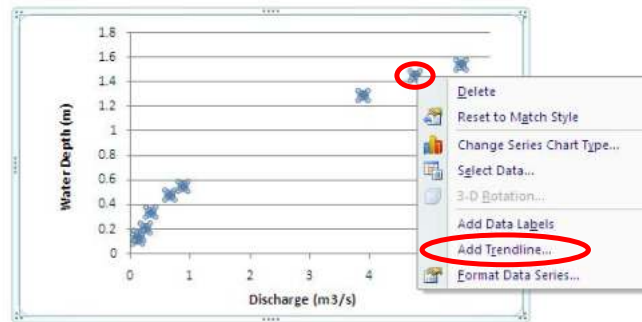

4. Select “Add Trendline” and then select “Polynomial”.

5. Check “Order” and insert “2”, herein “2” means the quadratic.

6. Check “Display Equation on chart” and close.

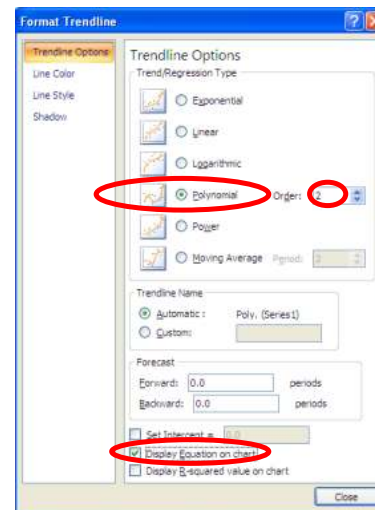
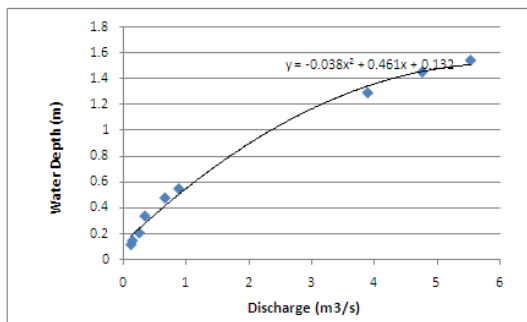

ANNEX-12: DIAGRAM MAKING OF HYDROGRAPH

Procedure of diagram making is as follows.

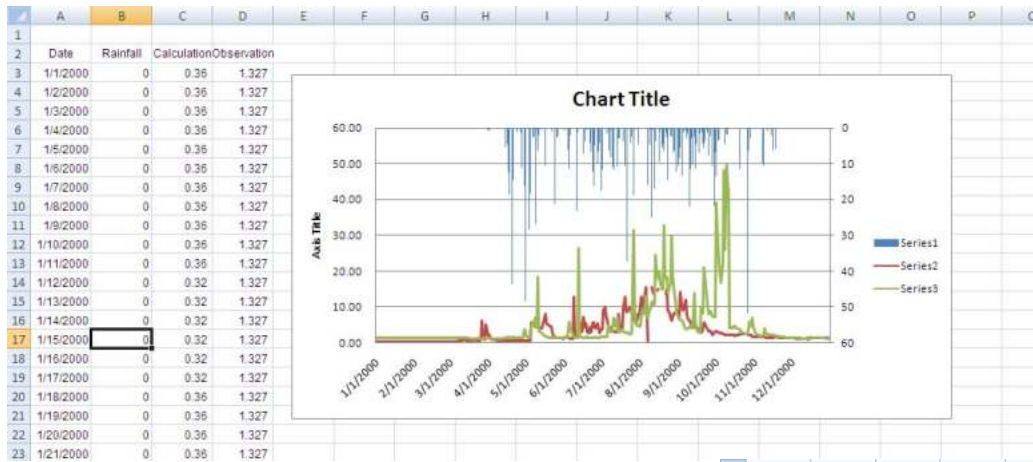

1. Make the file consisting of date, rainfall and calculated and observed discharge such as right sample.

Date	Rainfall	Calculation	Observation
1/1/2000	0	0.36	1.327
1/2/2000	0	0.36	1.327
1/3/2000	0	0.36	1.327
1/4/2000	0	0.36	1.327
1/5/2000	0	0.36	1.327
1/6/2000	0	0.36	1.327
1/7/2000	0	0.36	1.327
1/8/2000	0	0.36	1.327
1/9/2000	0	0.36	1.327
1/10/2000	0	0.36	1.327
1/11/2000	0	0.36	1.327
1/12/2000	0	0.32	1.327
1/13/2000	0	0.32	1.327
1/14/2000	0	0.32	1.327
1/15/2000	0	0.32	1.327
1/16/2000	0	0.32	1.327

2. Select the data of date, rainfall and discharge. Then, go to “Insert” tab, select “Line” and select “Line”. Then, the following graph appears.

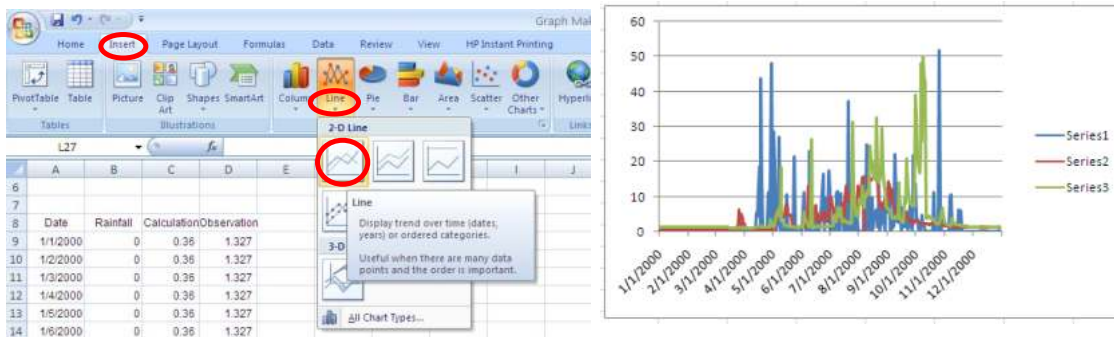

3. Click on the graph, select “layout-1” of “Design” tab of “Chart Tools”.

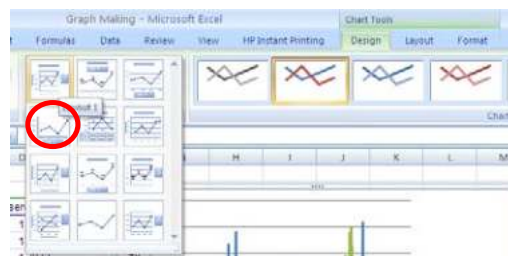

4. Modify the graph title and axis label and then double click on the line of rainfall (blue line).
Select the **second axis** and close.

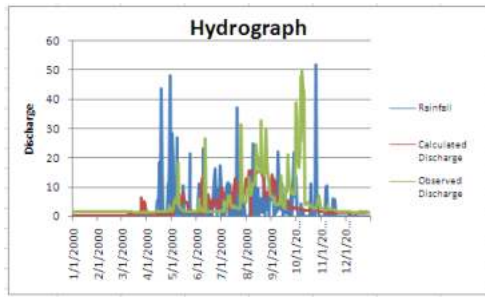

5. Select **second axis** on the graph and then right click. Select **Format Axis**.

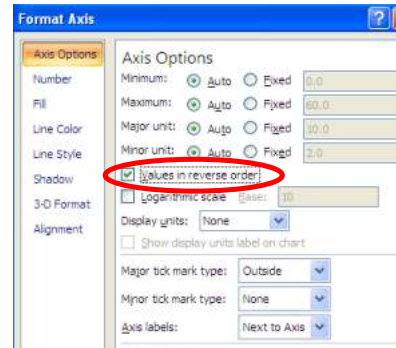
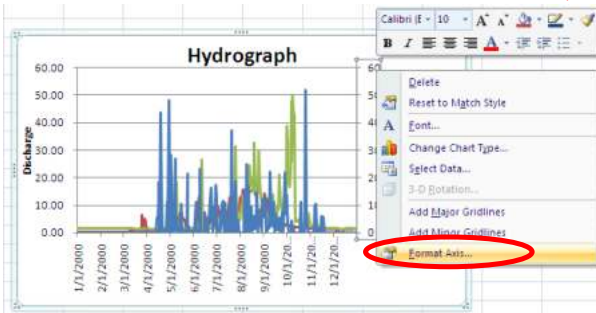
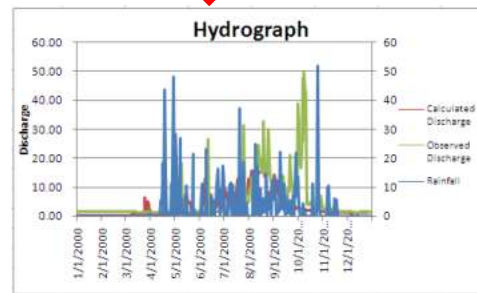

6. Check **Values in reverse order** and close.

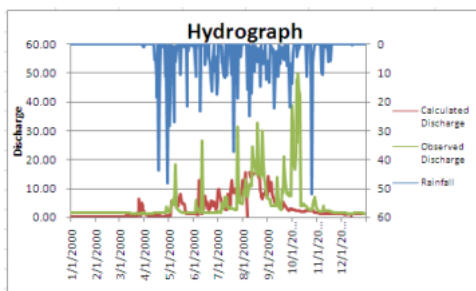

7. Select the rainfall data on the graph and then right click. Select **Change Series Chart Type**.

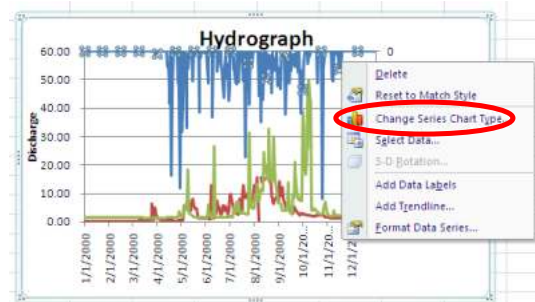

8. Select “**Clustered Column**” and click OK.

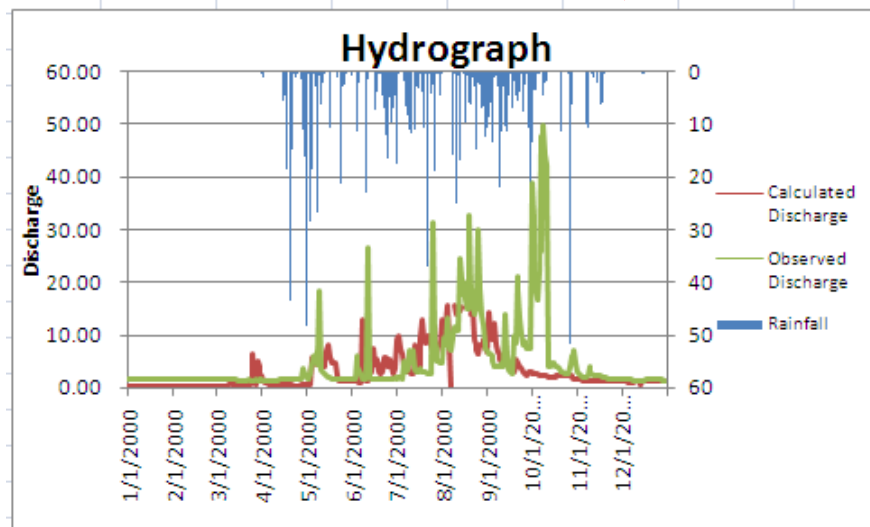
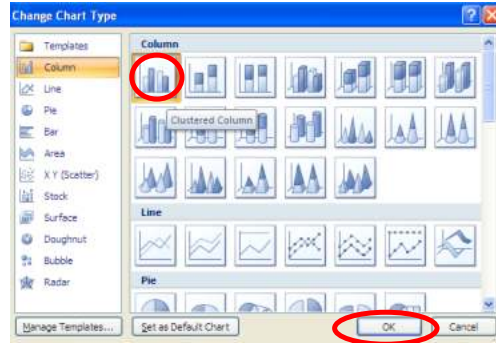

ANNEX-13: BOUNDARY OF THE DAY

Daily rainfall data is issued from NMA and the boundary of the day is 9 AM on this data. It is important to remember that there is the difference of dairy rainfall between on 9 AM boundary and 0 AM boundary.

Refer to the following figure;

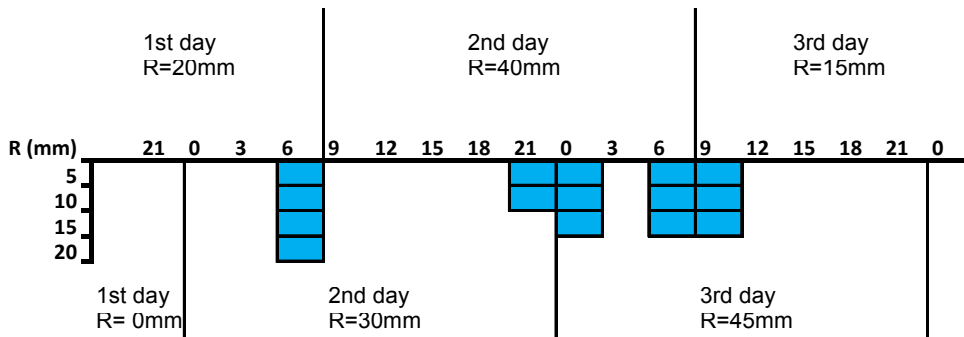

In case of 9 AM boundary (upper side), dairy rainfalls of 1st day, 2nd day and 3rd day are 20mm, 40mm and 15mm respectively.

But, in case of 0 AM boundary (lower side), dairy rainfalls of 1st day, 2nd day and 3rd day are 0mm, 30mm and 45mm respectively (shown in following figure).

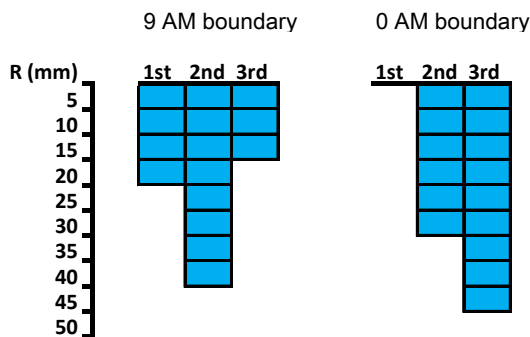

ANNEX-14: CORRELATION CALCULATION

Procedure of correlation calculation by EXCEL (Excel 2007) is as follows. If there is no tool of “data analysis”, install this first.

1. Make the file of “Monthly Rainfall” and open it.



Go to “Data” tab and look for

the “Data Analysis”. If there is a tool of “Data Analysis” on the right end of tool bar, go to 5. If there is not on a tool bar, as follows.

2. Select “Office Button” and then select “Excel Option”.

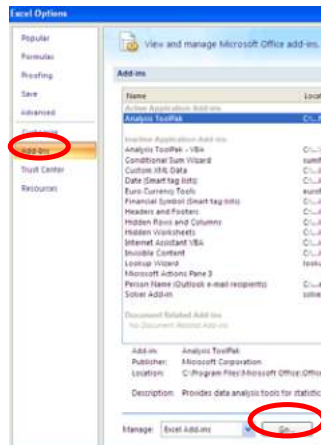

3. Select “Add Ins” and then select “Go”.

4. Check “Analysis ToolPak”, and then OK.

5. Example of “Monthly Rainfall” shows below. The set of data are 17 months and 4 stations.

YEAR	Month	ASSELA	Sire	Ditis Sude	Mekasa(IAR)
1990	1	0	0	-	-
1990	2	111.7	-	161.1	102.3
1990	3	93	37.5	6.2	57.7
1990	4	92.1	-	152.1	80.7
1990	5	22.8	53.8	46.1	12.2
1990	6	92.1	38.5	76.9	3.3
1990	7	197.8	184.7	84.5	127.1
1990	8	186.4	105.6	114.1	229.2
1990	9	153.7	153.2	117.3	-
1990	10	6.9	13.1	24.1	-
1990	11	11.2	0	19.8	0
1990	12	0	1.8	1.9	0
1991	1	0	0	12.7	0
1991	2	42.4	30.9	30.7	46.2
1991	3	142.3	99.3	144.3	-
1991	4	34.4	41.9	51.1	10.3
1991	5	57.6	46.8	122.7	-

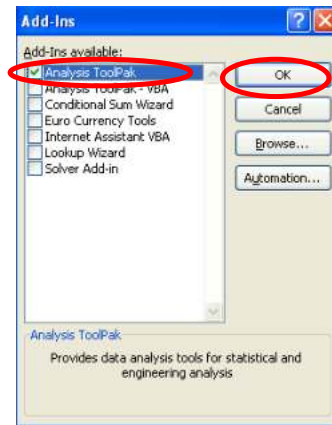

In the correlation calculation, it is necessary to complete the data set. Even the data of one station is missing, this date is not able to use in the correlation calculation. Therefore, available data set is reduced to 10.

YEAR	Month	ASSELA	Sire	Dixis Sude	Mekasa(AR)
1990	3	93	37.5	6.2	57.7
1990	5	22.8	53.8	46.1	12.2
1990	6	92.1	38.5	76.9	3.3
1990	7	197.8	184.7	84.5	127.1
1990	8	186.4	105.6	114.1	220.2
1990	11	11.2	0	19.8	0
1990	12	0	1.8	1.9	0
1991	1	0	0	12.7	0
1991	2	42.4	30.9	30.7	46.2
1991	4	34.4	41.9	51.1	10.3

6. Select “Data” tab and then select “Data Analysis”, and then select “correlation” and OK.

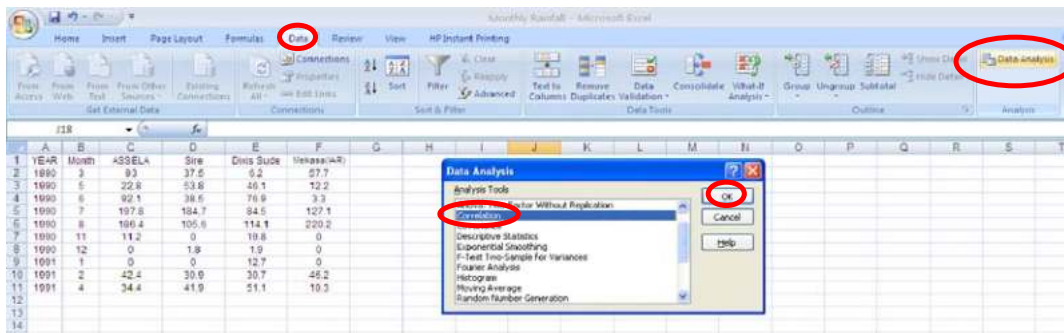

7. Select the range of data in “Input Range” and then input the “Output Range” and OK.

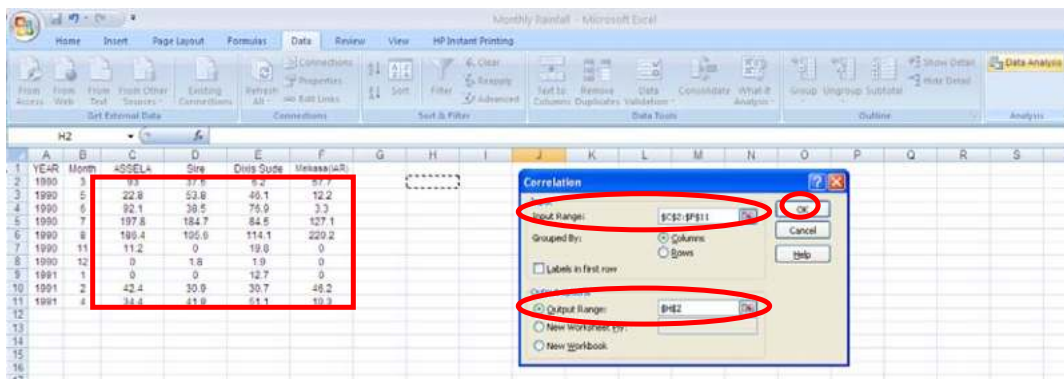

8. Result appears at the selected location.

	Column 1	Column 2	Column 3	Column 4
Column 1	1			
Column 2	0.892233	1		
Column 3	0.800023	0.751609	1	
Column 4	0.875221	0.748074	0.725908	1

9. Select station names names and copy. Go to column of correlation table and paste.

Furthermore, when you paste these lengthwise,

you can select “paste special”, and then check “transpose”.

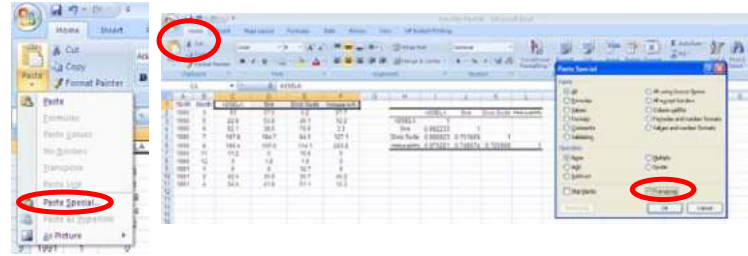

ANNEX-15: CORRELATION OF DISCHARGE

Correlation of monthly mean discharge among 2 rivers is as follows.

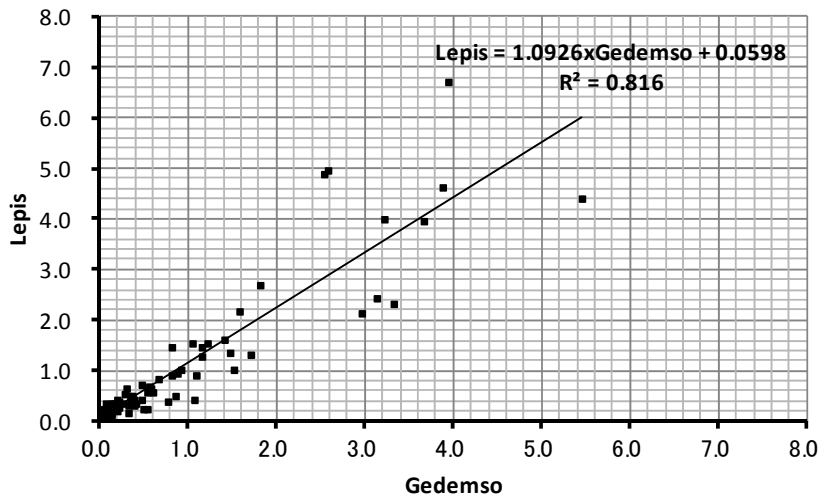
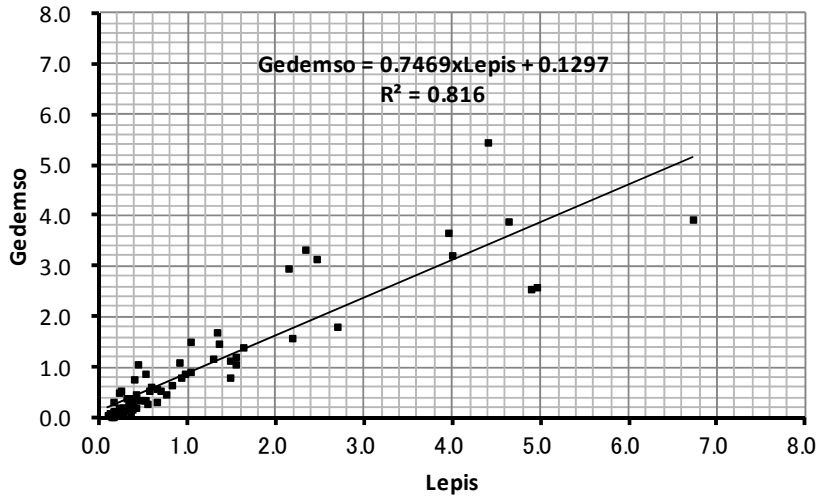

ANNEX-16: GRAPH OF NORMAL AND LOG SCALE

NORMAL SCALE

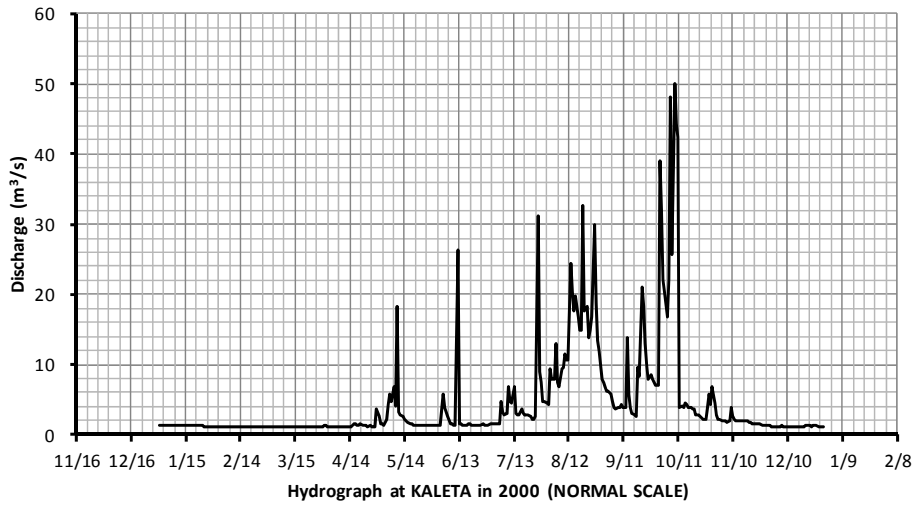

LOG SCALE

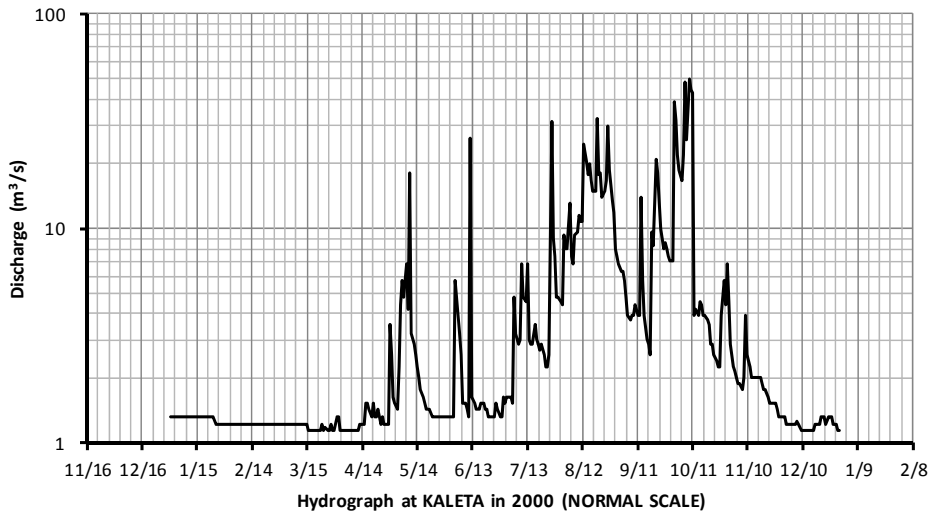

ANNEX-17: CALCULATION FORMAT OF TANK MODEL

The format to perform Tank Model is shown below.

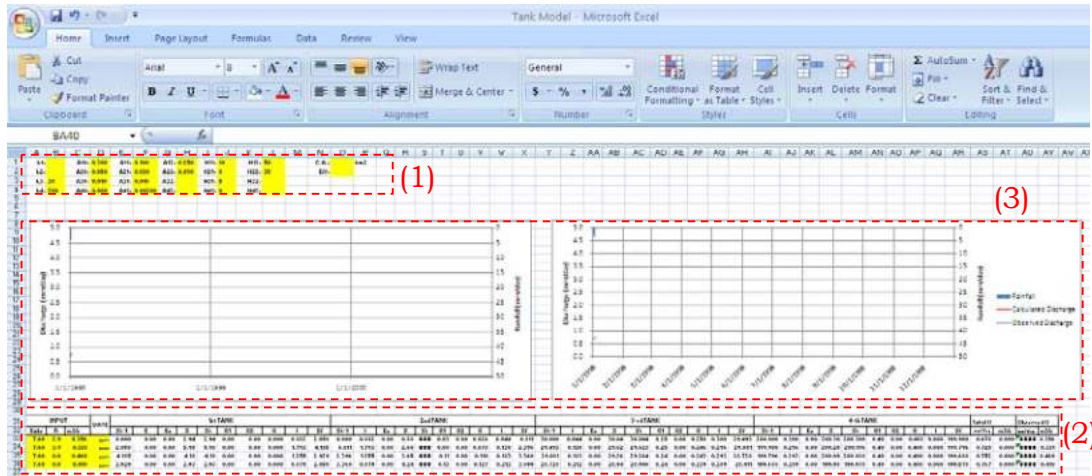

(1) expresses initial storage, coefficient of outlet size, height of outlets, catchment area of target basin and correction coefficient for evapotranspiration (referring to 6.1.2). Yellow cell means direct input. Catchment area and correction coefficient for evapotranspiration is fixed value. Tank model is made so that the calculated discharge simulates the observed discharge by changing the value of height of initial storage, coefficient of size of outlets and height of outlets.

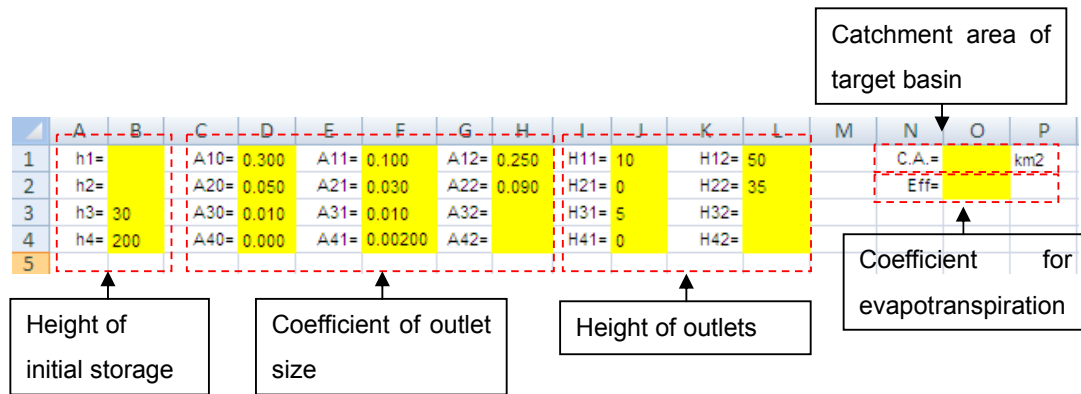

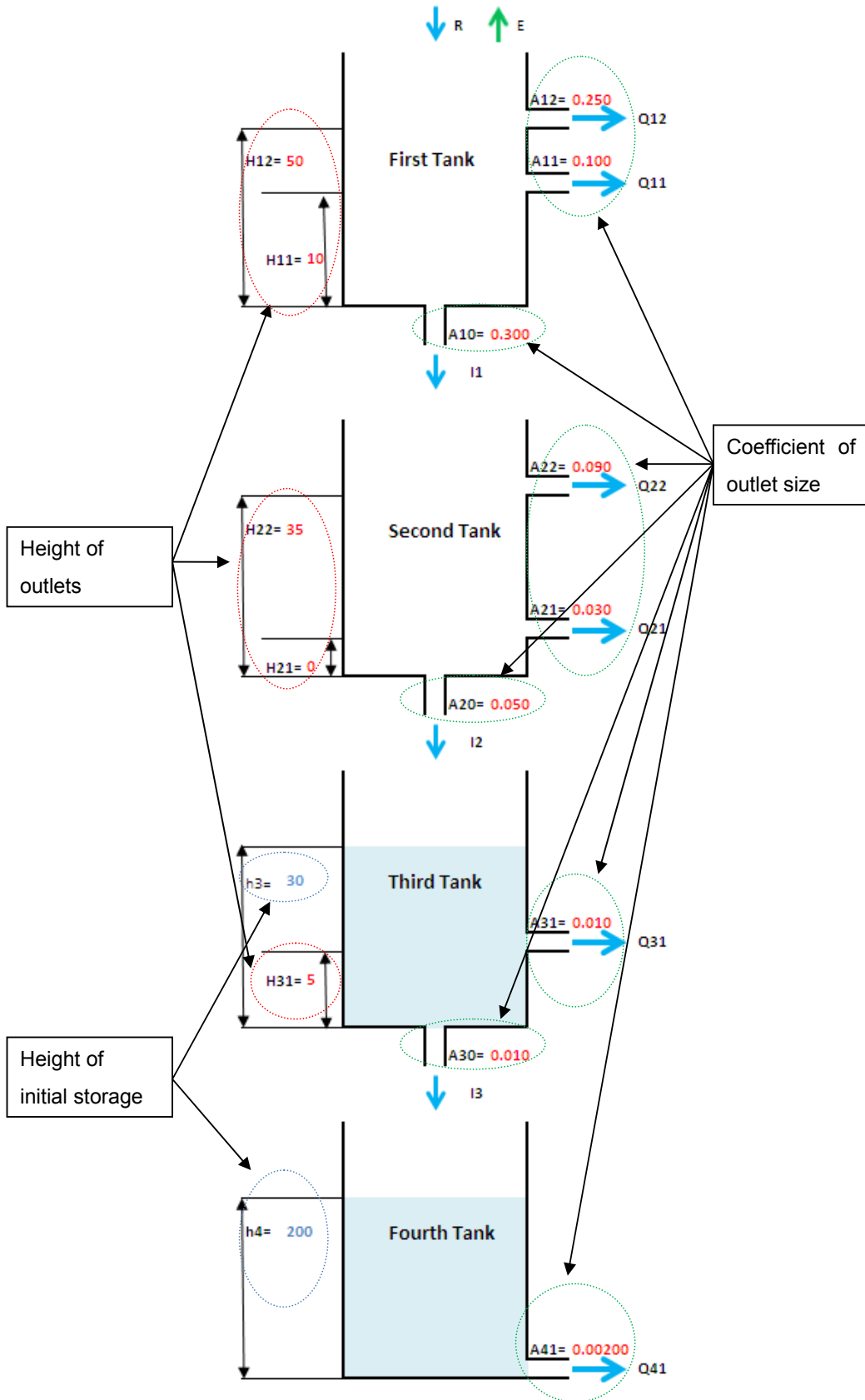

(2) shows input data, elements of each tanks and output.

Input data means daily mean observed evapotranspiration, areal rainfall of target basin, observed discharge data and date. Yellow cell is also direct input here.

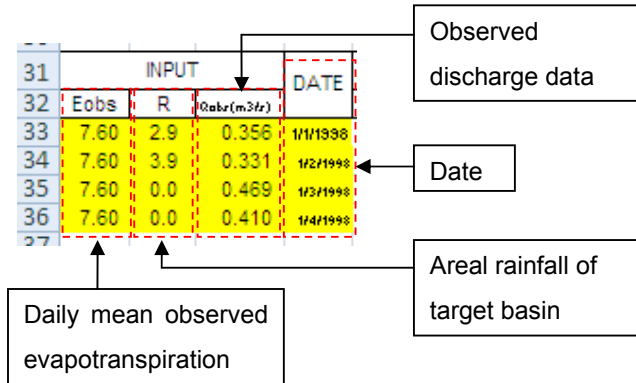

Regarding elements of each tanks, the elements is almost same on all tanks. These can be calculated by entering the formula on each cell. The way of entering the formula is explained later. Elements of each tanks is storage of the tank of the previous day ($St-1$), infiltration from upper tank (Ip), evapotranspiration modified by corrected coefficient for evapotranspiration (E), evapotranspiration in consideration of rainfall (Ee), storage of the tank in consideration of rainfall and evapotranspiration (S), corrected storage of the tank in case that value of S is minus (St), discharge form outlet 1 ($Q1$), discharge from outlet 2 ($Q2$), total discharge from outlets (Q), infiltration to next tank (I) and storage of the tank of the day (Sf).

2nd TANK									
St-1	Ip	Ee	S	St	Q1	Q2	Q	I	Sf
0.000	0.882	0.00	0.88	0.882	0.03	0.00	0.026	0.044	0.811
0.811	1.793	0.00	2.60	2.605	0.08	0.00	0.078	0.130	2.396
2.396	1.255	0.00	3.65	3.652	0.11	0.00	0.110	0.183	3.360
3.360	0.879	0.00	4.24	4.238	0.13	0.00	0.127	0.212	3.899

There is not Ip in 1st Tank because it is the most upper tank. Besides, in case that only one is set as side outlet or there is no bottom outlet such as 4th Tank, $Q2$ or I is always zero. In addition, E is calculated on only 1st Tank.

Output is total calculated discharge by Tank model. If the values of the observed discharge are put next to the calculated discharge, it is easier to compare the calculated discharge with the observed discharge.

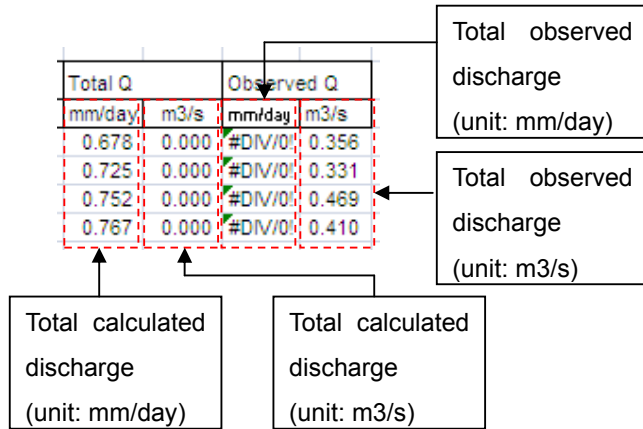

(3) expresses calculated discharge, observed discharge and rainfall on the graph. There are 2 graphs on the above sample picture. One reflects the data of all years you enter and another reflects the data of one year. Looking at the graph of one year, the value of height of initial storage, coefficient of size of outlets and height of outlets can be decided so that that the calculated discharge simulates the observed discharge. Please refer to ANNEX-12 about the way of making these graphs.

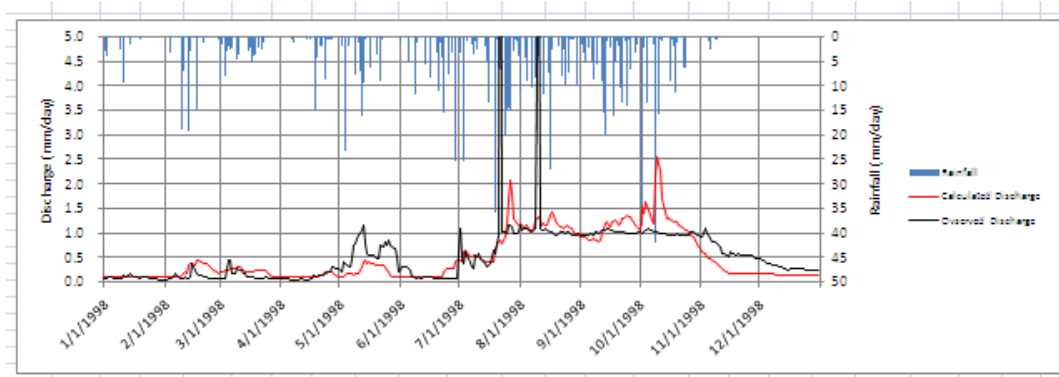
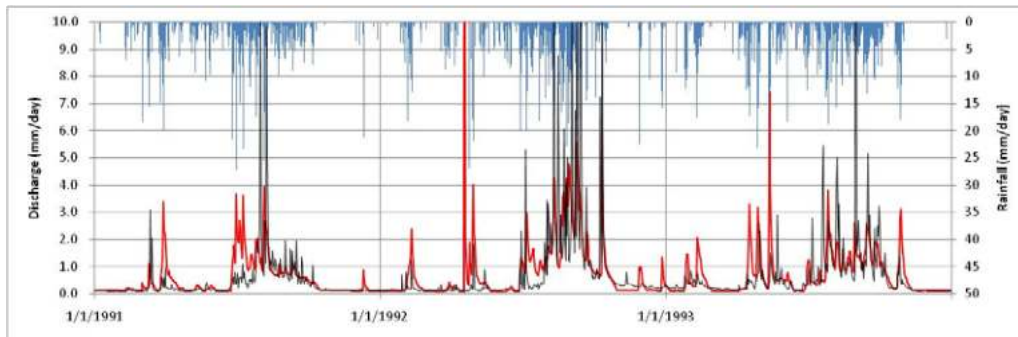

Regarding (2), the formula entered in the cells of each element is explained below. Incidentally, [] means the cell of the appropriate element. So, its cell

has to be entered into []. Abbreviation explained in the sentence or picture above is used below.

➤ 1stTank (the most upper tank)

1st TANK									
St-1	E	Ee	S	St	Q1	Q2	Q	I	Sf
0.000	0.00	0.00	2.94	2.94	0.00	0.00	0.000	0.882	2.058
2.058	0.00	0.00	5.98	5.98	0.00	0.00	0.000	1.793	4.185
4.185	0.00	0.00	4.18	4.18	0.00	0.00	0.000	1.255	2.929
2.929	0.00	0.00	2.93	2.93	0.00	0.00	0.000	0.879	2.050

Elements	Formula
St-1(top cell)	=[h1]
St-1(under second cell)	=[Sf (previous day)]
E	=[Eff] * [Eobs]
Ee	=If([R] >=0.5,[E]/2,[E])
S	=[R]+[St-1]-[Ee]
St	=If([S]<0,0,[S])
Q1	=If([St]<[H11],0,([St]-[H11])*[A11])
Q2	=If([St]<[H12],0,([St]-[H12])*[A12])
Q	=[Q1]+[Q2]
I	=[St]*[A10]
Sf	=[St]-[Q]-[I]

➤ 2ndTank

2nd TANK									
St-1	Ip	Ee	S	St	Q1	Q2	Q	I	Sf
0.000	0.882	0.00	0.88	0.882	0.03	0.00	0.026	0.044	0.811
0.811	1.793	0.00	2.60	2.605	0.08	0.00	0.078	0.130	2.396
2.396	1.255	0.00	3.65	3.652	0.11	0.00	0.110	0.183	3.360
3.360	0.879	0.00	4.24	4.238	0.13	0.00	0.127	0.212	3.899

Elements	Formula
St-1(top cell)	=[h2]
St-1(under second cell)	=[Sf (previous day)]
Ip	=[I (1st Tank)]
Ee	=If([St(1st Tank)]<0,-[St(1st Tank)],0)
S	=[St-1]+[Ip]-[Ee]

St	=If([S]<0,0,[S])
Q1	=If([St]<[H21],0,([St]-[H21])*[A21])
Q2	=If([St]<[H22],0,([St]-[H22])*[A22])
Q	=[Q1]+[Q2]
I	=[St]*[A20]
Sf	=[St]-[Q]-[I]

➤ 3rdTank

3-rd TANK									
St-1	Ip	Ee	S	St	Q1	Q2	Q	I	Sf
30.000	0.044	0.00	30.04	30.044	0.25	0.00	0.250	0.300	29.493
29.493	0.130	0.00	29.62	29.623	0.25	0.00	0.246	0.296	29.081
29.081	0.183	0.00	29.26	29.264	0.24	0.00	0.243	0.293	28.728
28.728	0.212	0.00	28.94	28.940	0.24	0.00	0.239	0.289	28.411

Elements	Formula
St-1(top cell)	=[h3]
St-1(under second cell)	=[Sf (previous day)]
Ip	=[I (2nd Tank)]
Ee	=If([St(2nd Tank)]<0,-[St(2nd Tank)],0)
S	=[St-1]+[Ip]-[Ee]
St	=If([S]<0,0,[S])
Q1	=If([St]<[H31],0,([St]-[H31])*[A31])
Q2	=If([St]<[H32],0,([St]-[H32])*[A32])
Q	=[Q1]+[Q2]
I	=[St]*[A30]
Sf	=[St]-[Q]-[I]

➤ 4thTank

4-th TANK									
St-1	Ip	Ee	S	St	Q1	Q2	Q	I	Sf
200.000	0.300	0.00	200.30	200.300	0.40	0.00	0.401	0.000	199.900
199.900	0.296	0.00	200.20	200.196	0.40	0.00	0.400	0.000	199.796
199.796	0.293	0.00	200.09	200.088	0.40	0.00	0.400	0.000	199.688
199.688	0.289	0.00	199.98	199.978	0.40	0.00	0.400	0.000	199.578

Elements	Formula
St-1(top cell)	=h4]
St-1(under second cell)	=Sf (previous day)]
Ip	=I (3rd Tank)]
Ee	=If([St(3rd Tank)]<0,-[St(3rd Tank)],0)
S	=St-1]+[Ip]-[Ee]
St	=If([S]<0,0,[S])
Q1	=If([St]<[H4 1],0,([St]-[H4 1])*[A4 1])
Q2	=If([St]<[H42],0,([St]-[H42])*[A42])
Q	=Q1]+[Q2]
I	=St]*[A40]
Sf	=St]-[Q]-[I]

➤ Output

Total Q		Observed Q	
mm/day	m3/s	mm/day	m3/s
0.678	0.000	#DIV/0!	0.356
0.725	0.000	#DIV/0!	0.331
0.752	0.000	#DIV/0!	0.469
0.767	0.000	#DIV/0!	0.410

Elements	Formula
Total Q (mm/day)	=Q(1st Tank)]+[Q(2nd Tank)]+[Q(3rd Tank)]+[Q(4th Tank)]
Total Q (m3/s)	=Ttal Q(mm/day)]*[C.A.]/86.4
Observed Q (mm/day)	=If([Qobs(m3/s)]=-“,”-“, [Qobs(m3/s)]*86.4/[C.A.]
Observed Q (m3/s)	=Qobs(m3/s)]

References

1. Tank Model, Water Resources Research; Vol.9, Sugawara M., 1973
2. Example of Runoff Calculation-2, Association of All Japan Construction Technology, 21-79, Hydrological Group; Ministry of Construction, 1971
3. ARCSWAT Interface for SWAT2009 User's Guide, M.Winchell et al, 2010
4. The Areal Reduction Factor (ARF) a Multifractal Analysis, Andreas Langousis, 2003

List of Authors

Name of Guidelines and Manuals	Name	Field	Affiliation
Guideline for Irrigation Master Plan Study Preparation on Surface Water Resources	Mr. Nobuhiko Suzuki	Water resources planning	Ministry of Agriculture, Forestry and Fisheries
	Mr. Roba Muhyedin	Irrigation Engineer	OIDA Head Office
Manual for Runoff Analysis	Mr. Yasukazu Kobayashi	Runoff Analysis	LANDTEC JAPAN, Inc.
Manual of GIS for ArcGIS (Basic & Advanced Section)	Mr. Ron Nagai	GIS Application	KOKUSAI KOGYO CO., LTD.
Manual on Land Use Classification Analysis Using Remote Sensing	Mr. Kazutoshi Masuda	Remote Sensing	KOKUSAI KOGYO CO., LTD.
Guidance for Oromia Irrigation Development Project Implementation	Mr. Kenjiro Futagami	Facility Design/Construction Supervision	Ministry of Agriculture, Forestry and Fisheries
Study and Design Technical Guideline for Irrigation Projects (Irrigation Engineering Part)	Mr. Naoto Takano	Facility Design/Construction Supervision	Ministry of Agriculture, Forestry and Fisheries
(Socio-Economy, Community, Financial and Economic analysis Part)	Mr. Tafesse Andargie	Economist	OIDA Head Office
(Agronomy and Soil Part)	Mr. Abdeta Nate'a	Agronomist	OIDA Head Office
Technical Guideline for Design of Headworks	Mr. Motohisa Wakatsuki	Head works design	Sanyu Consultants Inc.
Technical Guideline for Small Scale Reservoir	Mr. Haruo Hiki	Project Management/Planning/Reservoir	Sanyu Consultants Inc.
Technical Guideline for Irrigation Canal and Related Structures	Mr. Naoto Takano	Facility Design/Construction Supervision	Ministry of Agriculture, Forestry and Fisheries
Construction Control Manual	Mr. Yoshiaki Otsubo	Construction Supervision (Bura SSSIP)	Tokura Corporation
Guidance for Preparation of Operation and Maintenance Manual	Mr. Kenjiro Futagami	Facility Design/Construction Supervision	Ministry of Agriculture, Forestry and Fisheries
Irrigation Water Users Association Formation and Development Manual	Mr. Tafesse Andargie	Economist	OIDA Head Office
Strengthening Irrigation Water Users Association (IWUA) Guideline	Mr. Yasushi Osato	Strengthening of WUA	Nippon Koei Co.
	Mr. Tafesse Andargie	Economist	OIDA Head Office
Small Scale Irrigation Water Management Guideline (Irrigation Water Supply Part)	Mr. Yohannes Geleta	Irrigation Engineer	OIDA Head Office
(Field Irrigation Water Management Part)	Mr. Abdeta Nate'a	Agronomist	OIDA Head Office

Remarks: Affiliation is shown when he work for CBID project.

List of Experts who contributed to revise guidelines and manuals (1/5)

Office	Name	Specialty
OIDA Head office	Mr. Abdeta Nate'a	Agronomist
OIDA Head office	Mr. Kibrom Driba	Irrigation Engineer
OIDA Head office	Mr. Kurabachew Shewawerk	Agronomist
OIDA Head office	Mr. Lemma Adane	Irrigation Engineer
OIDA Head office	Mr. Roba Muhyedin	Irrigation Engineer
OIDA Head office	Mr. SHEMELES Tefera	Agronomist
OIDA Head office	Ms. Sintayehu Getahun	Irrigation Engineer
OIDA Head office	Mr. Tafesse Andargie	Economist
OIDA Head office	Mr. Tafesse Tsegaye	Irrigation Engineer
OIDA Head office	Mr. Tatek Worku	Irrigation Engineer
OIDA Head office	Mr. Teferi Dhaba	Irrigation Engineer
OIDA Head office	Mr. Terfasa Fite	Irrigation Engineer
OIDA Head office	Mr. Tesfaye Deribe	Irrigation Engineer
OIDA Head office	Mr. Yohannes Dessalegn	Economist
OIDA Head office	Mr. Yohannes Geleta	Irrigation Engineer
OWMEB	Mr. Girma Etana	Irrigation Engineer
OWMEB	Mr. Kedir Lole	Irrigation Engineer
Arsi	Mr. Dedefi Ediso	Agronomist
Arsi	Mr. Birhanu Mussie	Irrigation Engineer
Arsi	Mr. Dinberu Abera	Sociologist
Arsi	Mr. Hussien Beriso	Economist
Arsi	Mr. Mulat Teshome	Surveyor
Arsi	Mr. Segni Bilisa	Agronomist
Arsi	Mr. Shewngezew Legesse	Irrigation Engineer

List of Experts who contributed to revise guidelines and manuals (2/5)

Office	Name	Specialty
Arsi	Mr. Tamerwold Elias	Irrigation Engineer
Arsi	Mr. Tesfaye Gudisa	Irrigation engineer
Arsi	Mr. Teshome Eda'e	Irrigation Engineer
Arsi	Ms. Worknesh Kine	Geologist
Bale	Mr. Abboma Terresa	Irrigation Engineer
Bale	Mr. Abdulreshed Namu	Irrigation Engineer
Bale	Mr. Beyan Ahmed	Economist
Bale	Mr. Diriba Beyene	Irrigation Engineer
Bale	Mr. Firew Demeke Teferi	Irrigation engineer
Bale	Mr. Gosa Taye Debela	Irrigation engineer
Bale	Mr. Zeleke Agonafir	Agronomist
Borena	Mr. Dida Sola	Irrigation Engineer
East Harerge	Mr. Abdi Abdulkedar	Irrigation Engineer
East Harerge	Mr. Elias Abdi	Irrigation Engineer
East Harerge	Mr. Shemsedin kelil	Irrigation Engineer
East Harerge	Ms. Eskedar Mulatu	Economist
East Shewa	Mr. Andaregie Senbeta	Economist
East Shewa	Mr. Bekele Gebre	Irrigation Engineer
East Shewa	Mr. Dilibi ShekAli	Sociologist
East Shewa	Mr. Ejara Tola	Agronomist
East Shewa	Mr. Girma Niguse	Irrigation Engineer
East Shewa	Mr. Kebebew Legesse	Irrigation Engineer
East Shewa	Mr. Mulatu Wubishet	Agronomist
East Shewa	Mr. Tadesse Mekuria	Agronomist

List of Experts who contributed to revise guidelines and manuals (3/5)

Office	Name	Specialty
East Shewa	Ms. Tigist Amare	Irrigation Engineer
East Shewa	Mr. Zerfu Seifu	Irrigation Engineer
East Welega	Mr. Benti Abose	Economist
East Welega	Mr. Birhanu Yadete	Agronomist
East Welega	Mr. Dasalegn Tesema	Economist
East Welega	Mr. Gamachis Asefa	Irrigation Engineer
East Welega	Mr. Getachew Irena	Agronomist
East Welega	Mr. Kidane Fekadu	Irrigation Engineer
East Welega	Mr. Milikesa Workeneh	Irrigation Engineer
East Welega	Ms. Mulunesh Bekele	Irrigation Engineer
East Welega	Mr. Samson Abdu	Irrigation Engineer
East Welega	Mr. Tulam Admasu	Irrigation Engineer
East Welega	Ms. Yeshimebet Bule	Economist
Guji	Mr. Abadir Sultan	Sociology
Guji	Mr. Dawud Menza	Irrigation Engineer
Guji	Mr. Fikadu Mekonin	Geologist
Guji	Mr. Megersa Ensermu	Irrigation Engineer
Guji	Mr. Wandesen Bakale	Economist
Horoguduru Welega	Mr. Seleshi Terfe	Economist
Horoguduru Welega	Mr. Temesgen Mekonnen	Irrigation Engineer
Horoguduru Welega	Mr. Tesfaye Chimdessa	Economist
Illubabor	Mr. Ahmed Sani	Irrigation Engineer
Jimma	Mr. Lebeta Adera	Irrigation Engineer
Kelem Welega	Mr. Ayana Fikadu	Agronomist

List of Experts who contributed to revise guidelines and manuals (4/5)

Office	Name	Specialty
Kelem Welega	Mr. Megarsa Kumara	Hydrologist
Kelem Welega	Mr. Oda Teshome	Economist
Northe Shewa	Mr. Henok Girma	Irrigation Engineer
South West Shewa	Mr. Bedasa Tadele	Irrigation Engineer
South West Shewa	Mr. Gemechu Getachew	Irrigation Engineer
West Arsi	Mr. Abebe Gela	Irrigation Engineer
West Arsi	Mr. Demissie Gnorie	Irrigation Engineer
West Arsi	Mr. Feyisa Guye	Irrigation Engineer
West Arsi	Mr. Hashim Hussen	Economist
West Arsi	Mr. Jemal Jeldo	Economist
West Arsi	Mr. Mekonnen Merga	Environmentalist
West Arsi	Mr. Mohamedsafi Edris	Irrigation Engineer
West Arsi	Mr. Molla Lemesa	Agronomist
West Arsi	Mr. Tamene Kena	Sociologist
West Arsi	Mr. Tibaho Gobena	Irrigation Engineer
West Harerge	Mr. Alemayehu Daniel	Agronomist
West Harerge	Mr. Dereje Kefyalew	Irrigation Engineer
West Harerge	Mr. Ferid Hussen	Irrigation Engineer
West Harerge	Mr. Nuredin Adem	Irrigation Engineer
West Harerge	Mr. Seifu Gizaw	Economist
West Shewa	Mr. Jergna Dorsisa	Irrigation Engineer
West Shewa	Mr. Solomon Mengistu	Agronomist
West Shewa	Mr. Zerhun Abiyu	Irrigation Engineer
West Welega	Mr. Belaye kebede	Irrigation Engineer

List of Experts who contributed to revise guidelines and manuals (5/5)

Office	Name	Specialty
West Welega	Mr. Busa Degefe	Economist
West Welega	Mr. Temesgen Runda	Irrigation Engineer
Ministry of Agriculture	Mr. Amerga Kearsie	Irrigation Engineer
Ministry of Agriculture	Mr. Zegeye Kassahun	Agronomist
Amhara Agriculture Bureau	Mr. Assefa Zeleke	Economist
OWWDSE	Mr. Damtew Adefris	Irrigation Engineer
OWWDSE	Mr. Demelash Mulu	Irrigation Engineer
OWWDSE	Mr. Teshoma Wondemu	Irrigation Engineer
Latinsa SC.	Mr. Aschalew Deme	Irrigation Engineer
Latinsa SC.	Mr. Daba Feyisa	Agronomist
Metaferia Consulting Engineers	Mr. Getu Getoraw	Irrigation Engineer
Metaferia Consulting Engineers	Mr. Hassen Bahru	Sociologist
Metaferia Consulting Engineers	Ms. Nitsuh Seifu	Irrigation Engineer

Remarks: Office Name is shown when he/she works for CBID project.

List of Editors

Name of Guidelines and Manuals	Name	Field	Affiliation
<ul style="list-style-type: none"> Guideline for Irrigation Master Plan Study Preparation on Surface Water Resources 	Mr. Ermias Alemu Demissie	Irrigation Engineer	Lecturer in Arba Minch University
	Mr. Zerihun Anbesa	Hydrologist	Lecturer in Arba Minch University
<ul style="list-style-type: none"> Technical Guideline for Design of Headworks Technical Guideline for Irrigation Canal and Related Structures 	Mr. Ermias Alemu Demissie	Irrigation Engineer	Lecturer in Arba Minch University
	Mr. Bereket Bezabih	Hydraulic Engineer (Geo technical)	Lecturer in Arba Minch University
<ul style="list-style-type: none"> Construction Control Manual 	Mr. Eiji Takemori	Construction Supervision (Hirna SSIP)	LANDTEC JAPAN, Inc.
<ul style="list-style-type: none"> Construction Control Manual 	Dr. Hiroaki Okada	Construction Supervision (Sokido/Saraweba SSIP)	Sanyu Consultants Inc.
<ul style="list-style-type: none"> Construction Control Manual 	Mr. Shinsuke Kubo	Construction Supervision (Shaya SSIP)	Independent Consulting Engineer
<ul style="list-style-type: none"> Technical Guideline for Design of Headworks Construction Control Manual 	Mr. Toru Ikeuchi	Chief Advisor/Irrigation Technology	JIID (The Japanese Institute of Irrigation and Drainage)
<ul style="list-style-type: none"> Technical Guideline for Design of Headworks Construction Control Manual 	Mr. Kenjiro Futagami	Facility Design/Construction Supervision	Ministry of Agriculture, Forestry and Fisheries
<ul style="list-style-type: none"> All Guidelines and Manuals 	Mr. Hiromu Uno	Chief Advisor/Irrigation Technology	Ministry of Agriculture, Forestry and Fisheries
<ul style="list-style-type: none"> Manual for Runoff Analysis Manual of GIS for ArcGIS (Basic & Advanced Section) Manual on Land Use Classification Analysis Using Remote Sensing 	Mr. Nobuhiko Suzuki	Water resources planning	Ministry of Agriculture, Forestry and Fisheries
<ul style="list-style-type: none"> Guidance for Oromia Irrigation Development Project Implementation Study and Design Technical Guideline for Irrigation Projects Technical Guideline for Design of Headworks Technical Guideline for Small Scale Reservoir Construction Control Manual Guidance for Preparation of Operation and Maintenance Manual Irrigation Water Users Association Formation and Development Manual Strengthening Irrigation Water Users Association (IWUA) Guideline Small Scale Irrigation Water Management Guideline 	Mr. Naoto Takano	Facility Design/Construction Supervision	Ministry of Agriculture, Forestry and Fisheries

Remarks: Affiliation is shown when he work for CBID project.

List of Coordinators

Name	Field	Affiliation
Mr. Ryosuke Ito	Coordinator/Training	Independent
Mr. Tadashi Kikuchi	Coordinator/Training	Regional Planning International Co.

Remarks: Affiliation is shown when he work for CBID project.

List of Experts who contributed to revise guidelines and manuals (1/5)

Office	Name	Specialty
OIDA Head office	Mr. Abdeta Nate'a	Agronomist
OIDA Head office	Mr. Kibrom Driba	Irrigation Engineer
OIDA Head office	Mr. Kurabachew Shewawerk	Agronomist
OIDA Head office	Mr. Lemma Adane	Irrigation Engineer
OIDA Head office	Mr. Roba Muhyedin	Irrigation Engineer
OIDA Head office	Mr. Semeles Tefera	Agronomist
OIDA Head office	Ms. Sintayehu Getahun	Irrigation Engineer
OIDA Head office	Mr. Tafesse Andargie	Economist
OIDA Head office	Mr. Tafesse Tsegaye	Irrigation Engineer
OIDA Head office	Mr. Tatek Worku	Irrigation Engineer
OIDA Head office	Mr. Teferi Dhaba	Irrigation Engineer
OIDA Head office	Mr. Terfasa Fite	Irrigation Engineer
OIDA Head office	Mr. Tesfaye Deribe	Irrigation Engineer
OIDA Head office	Mr. Yohannes Dessalegn	Economist
OIDA Head office	Mr. Yohannes Geleta	Irrigation Engineer
OWMEB	Mr. Girma Etana	Irrigation Engineer
OWMEB	Mr. Kedir Lole	Irrigation Engineer
Arsi	Mr. Dedefi Ediso	Agronomist
Arsi	Mr. Birhanu Mussie	Irrigation Engineer
Arsi	Mr. Dinberu Abera	Sociologist
Arsi	Mr. Hussien Beriso	Economist
Arsi	Mr. Mulat Teshome	Surveyor
Arsi	Mr. Segni Bilisa	Agronomist
Arsi	Mr. Shewngezew Legesse	Irrigation Engineer

List of Experts who contributed to revise guidelines and manuals (2/5)

Office	Name	Specialty
Arsi	Mr. Tamerwold Elias	Irrigation Engineer
Arsi	Mr. Tesfaye Gudisa	Irrigation engineer
Arsi	Mr. Teshome Eda'e	Irrigation Engineer
Arsi	Ms. Worknesh Kine	Geologist
Bale	Mr. Abboma Terresa	Irrigation Engineer
Bale	Mr. Abdulreshed Namu	Irrigation Engineer
Bale	Mr. Beyan Ahmed	Economist
Bale	Mr. Diriba Beyene	Irrigation Engineer
Bale	Mr. Firew Demeke Teferi	Irrigation engineer
Bale	Mr. Gosa Taye Debela	Irrigation engineer
Bale	Mr. Zeleke Agonafir	Agronomist
Borena	Mr. Dida Sola	Irrigation Engineer
East Harerge	Mr. Abdi Abdulkedar	Irrigation Engineer
East Harerge	Mr. Elias Abdi	Irrigation Engineer
East Harerge	Mr. Shemsedin kelil	Irrigation Engineer
East Harerge	Ms. Eskedar Mulatu	Economist
East Shewa	Mr. Andaregie Senbeta	Economist
East Shewa	Mr. Bekele Gebre	Irrigation Engineer
East Shewa	Mr. Dilibi ShekAli	Sociologist
East Shewa	Mr. Ejara Tola	Agronomist
East Shewa	Mr. Girma Niguse	Irrigation Engineer
East Shewa	Mr. Kebebew Legesse	Irrigation Engineer
East Shewa	Mr. Mulatu Wubishet	Agronomist
East Shewa	Mr. Tadesse Mekuria	Agronomist

List of Experts who contributed to revise guidelines and manuals (3/5)

Office	Name	Specialty
East Shewa	Ms. Tigist Amare	Irrigation Engineer
East Shewa	Mr. Zerfu Seifu	Irrigation Engineer
East Welega	Mr. Benti Abose	Economist
East Welega	Mr. Birhanu Yadete	Agronomist
East Welega	Mr. Dasalegn Tesema	Economist
East Welega	Mr. Gamachis Asefa	Irrigation Engineer
East Welega	Mr. Getachew Irena	Agronomist
East Welega	Mr. Kidane Fekadu	Irrigation Engineer
East Welega	Mr. Milikesa Workeneh	Irrigation Engineer
East Welega	Ms. Mulunesh Bekele	Irrigation Engineer
East Welega	Mr. Samson Abdu	Irrigation Engineer
East Welega	Mr. Tulam Admasu	Irrigation Engineer
East Welega	Ms. Yeshimebet Bule	Economist
Guji	Mr. Abadir Sultan	Sociology
Guji	Mr. Dawud Menza	Irrigation Engineer
Guji	Mr. Fikadu Mekonin	Geologist
Guji	Mr. Megersa Ensermu	Irrigation Engineer
Guji	Mr. Wandesen Bakale	Economist
Horoguduru Welega	Mr. Seleshi Terfe	Economist
Horoguduru Welega	Mr. Temesgen Mekonnen	Irrigation Engineer
Horoguduru Welega	Mr. Tesfaye Chimdessa	Economist
Illubabor	Mr. Ahmed Sani	Irrigation Engineer
Jimma	Mr. Lebeta Adera	Irrigation Engineer
Kelem Welega	Mr. Ayana Fikadu	Agronomist

List of Experts who contributed to revise guidelines and manuals (4/5)

Office	Name	Specialty
Kelem Welega	Mr. Megarsa Kumara	Hydrologist
Kelem Welega	Mr. Oda Teshome	Economist
Northe Shewa	Mr. Henok Girma	Irrigation Engineer
South West Shewa	Mr. Bedasa Tadele	Irrigation Engineer
South West Shewa	Mr. Gemechu Getachew	Irrigation Engineer
West Arsi	Mr. Abebe Gela	Irrigation Engineer
West Arsi	Mr. Demissie Gnorie	Irrigation Engineer
West Arsi	Mr. Feyisa Guye	Irrigation Engineer
West Arsi	Mr. Hashim Hussen	Economist
West Arsi	Mr. Jemal Jeldo	Economist
West Arsi	Mr. Mekonnen Merga	Environmentalist
West Arsi	Mr. Mohamedsafi Edris	Irrigation Engineer
West Arsi	Mr. Molla Lemesa	Agronomist
West Arsi	Mr. Tamene Kena	Sociologist
West Arsi	Mr. Tibaho Gobena	Irrigation Engineer
West Harerge	Mr. Alemayehu Daniel	Agronomist
West Harerge	Mr. Dereje Kefyalew	Irrigation Engineer
West Harerge	Mr. Ferid Hussen	Irrigation Engineer
West Harerge	Mr. Nuredin Adem	Irrigation Engineer
West Harerge	Mr. Seifu Gizaw	Economist
West Shewa	Mr. Jergna Dorsisa	Irrigation Engineer
West Shewa	Mr. Solomon Mengistu	Agronomist
West Shewa	Mr. Zerhun Abiyu	Irrigation Engineer
West Welega	Mr. Belaye kebede	Irrigation Engineer

List of Experts who contributed to revise guidelines and manuals (5/5)

Office	Name	Specialty
West Welega	Mr. Busa Degefe	Economist
West Welega	Mr. Temesgen Runda	Irrigation Engineer
Ministry of Agriculture	Mr. Amerga Kearsie	Irrigation Engineer
Ministry of Agriculture	Mr. Zegeye Kassahun	Agronomist
Amhara Agriculture Bureau	Mr. Assefa Zeleke	Economist
OWWDSE	Mr. Damtew Adefris	Irrigation Engineer
OWWDSE	Mr. Demelash Mulu	Irrigation Engineer
OWWDSE	Mr. Teshoma Wondemu	Irrigation Engineer
Latinsa SC.	Mr. Aschalew Deme	Irrigation Engineer
Latinsa SC.	Mr. Daba Feyisa	Agronomist
Metaferia Consulting Engineers	Mr. Getu Getoraw	Irrigation Engineer
Metaferia Consulting Engineers	Mr. Hassen Bahru	Sociologist
Metaferia Consulting Engineers	Ms. Nitsuh Seifu	Irrigation Engineer

Remarks: Office Name is shown when he/she works for CBID project.

List of Editors

Name of Guidelines and Manuals	Name	Field	Affiliation
<ul style="list-style-type: none"> Guideline for Irrigation Master Plan Study Preparation on Surface Water Resources 	Mr. Ermias Alemu Demissie	Irrigation Engineer	Lecturer in Arba Minch University
	Mr. Zerihun Anbesa	Hydrologist	Lecturer in Arba Minch University
<ul style="list-style-type: none"> Technical Guideline for Design of Headworks Technical Guideline for Irrigation Canal and Related Structures 	Mr. Ermias Alemu Demissie	Irrigation Engineer	Lecturer in Arba Minch University
	Mr. Bereket Bezabih	Hydraulic Engineer (Geo technical)	Lecturer in Arba Minch University
<ul style="list-style-type: none"> Construction Control Manual 	Mr. Eiji Takemori	Construction Supervision (Hirna SSIP)	LANDTEC JAPAN, Inc.
<ul style="list-style-type: none"> Construction Control Manual 	Dr. Hiroaki Okada	Construction Supervision (Sokido/Saraweba SSIP)	Sanyu Consultants Inc.
<ul style="list-style-type: none"> Construction Control Manual 	Mr. Shinsuke Kubo	Construction Supervision (Shaya SSIP)	Independent Consulting Engineer
<ul style="list-style-type: none"> Technical Guideline for Design of Headworks Construction Control Manual 	Mr. Toru Ikeuchi	Chief Advisor/Irrigation Technology	JIID (The Japanese Institute of Irrigation and Drainage)
<ul style="list-style-type: none"> Technical Guideline for Design of Headworks Construction Control Manual 	Mr. Kenjiro Futagami	Facility Design/Construction Supervision	Ministry of Agriculture, Forestry and Fisheries
<ul style="list-style-type: none"> All Guidelines and Manuals 	Mr. Hiromu Uno	Chief Advisor/Irrigation Technology	Ministry of Agriculture, Forestry and Fisheries
<ul style="list-style-type: none"> Manual for Runoff Analysis Manual of GIS for ArcGIS (Basic & Advanced Section) Manual on Land Use Classification Analysis Using Remote Sensing 	Mr. Nobuhiko Suzuki	Water resources planning	Ministry of Agriculture, Forestry and Fisheries
<ul style="list-style-type: none"> Guidance for Oromia Irrigation Development Project Implementation Study and Design Technical Guideline for Irrigation Projects Technical Guideline for Design of Headworks Technical Guideline for Small Scale Reservoir Construction Control Manual Guidance for Preparation of Operation and Maintenance Manual Irrigation Water Users Association Formation and Development Manual Strengthening Irrigation Water Users Association (IWUA) Guideline Small Scale Irrigation Water Management Guideline 	Mr. Naoto Takano	Facility Design/Construction Supervision	Ministry of Agriculture, Forestry and Fisheries

Remarks: Affiliation is shown when he work for CBID project.

List of Coordinators

Name	Field	Affiliation
Mr. Ryosuke Ito	Coordinator/Training	Independent
Mr. Tadashi Kikuchi	Coordinator/Training	Regional Planning International Co.

Remarks: Affiliation is shown when he work for CBID project.

Contact Person

Mr. Yohannes Geleta (Irrigation Engineer; Environmentalist)

(Tel: 0911-981665, E-mail: yohketi@gmail.com)

Mr. Tafesse Andargie (Economist)

(Tel: 0911-718671, E-mail: andargietafesse@yahoo.com)

Mr. Abdeta Nate'a (Agronomist)

(Tel: 0912-230407, E-mail: abdetanatea@yahoo.com)

Oromia Irrigation Development Authority (OIDA)
Tel: 011-1262245

C/O JICA Ethiopia Office
Mina Building, 6th & 7th Floor,
P.O.Box 5384, Addis Ababa, Ethiopia
Tel : (251)-11-5504755
Fax: (251)-11-5504465